

TRADE PRICE LIST 2024



NEO

More than a plug

YOUR PARTNER FOR INTELLIGENT DISTRIBUTION SYSTEMS

When it comes to selecting and equipping suitable solutions and products for power distribution in the low voltage range, we are the right contact for you. At WALTHER-WERKE, we rely on comprehensive expertise, many years of market and industry experience, and enthusiasm for forward-looking solutions - and have been doing so since 1897. Our solutions and products are characterized by high quality, technological know-how and customer-oriented user benefits. When developing new products, we focus on innovative and sustainable solutions that are at the cutting edge of technology and offer the user absolute added value.

With over 500 employees worldwide, 60 international sales partners and 6 subsidiaries, 1 of which is in Germany and 5 of which are abroad, we are represented in all core markets. We develop, manufacture and distribute CEE plugs and sockets, industrial connectors, power distributors and charging solutions for electromobility worldwide.

In the cooperation with our customers, we rely on a strong, trusting partnership. We achieve this by being close to our customers and the industry at all levels. We always have an open ear for all the needs and concerns of our customers. Our customers can trust that we know their requirements precisely and offer solutions that are tailored to them. This is how we create trust and a good basis for a long-term partnership.



KEY CONTACTS



GROUP OF COMPANIES

- 500 employees worldwide
- 4 locations in Germany, including 1 subsidiary
- 5 subsidiaries (in Europa and the USA)
- 60 international distribution partners



SOLUTIONS

Intelligent distribution systems for:

- Electromobility
- Construction
- Industry



PRODUKT HIGHLIGHTS

- CEE plugs and sockets NEO
- Construction site power distributors
- Socket combinations
- Wallboxes and charging columns
- IPD software solution

THE CEE CLOCK ACCORDING TO IEC 60309-1

The international standard for CEE plugs and sockets is defined in the IEC 60309 standard. This was derived from the CEE17 standard, which was drafted by WALTHER-WERKE in the 1960s. IEC 60309 describes the requirements for plugs, sockets, cable couplings and device plugs and sockets for industrial applications.

The specified voltages and frequencies are prescribed for use in accordance with IEC 60309-1 (Series I). This standardisation means that the same plug-in system can be used for machines and systems worldwide. The colours of the individual standardised voltages and frequencies are recommendations of the standard and serve for identification. Important to know: The shaded clock positions (2h, 3h, 10h) are only standardised for 16 A and 32 A.

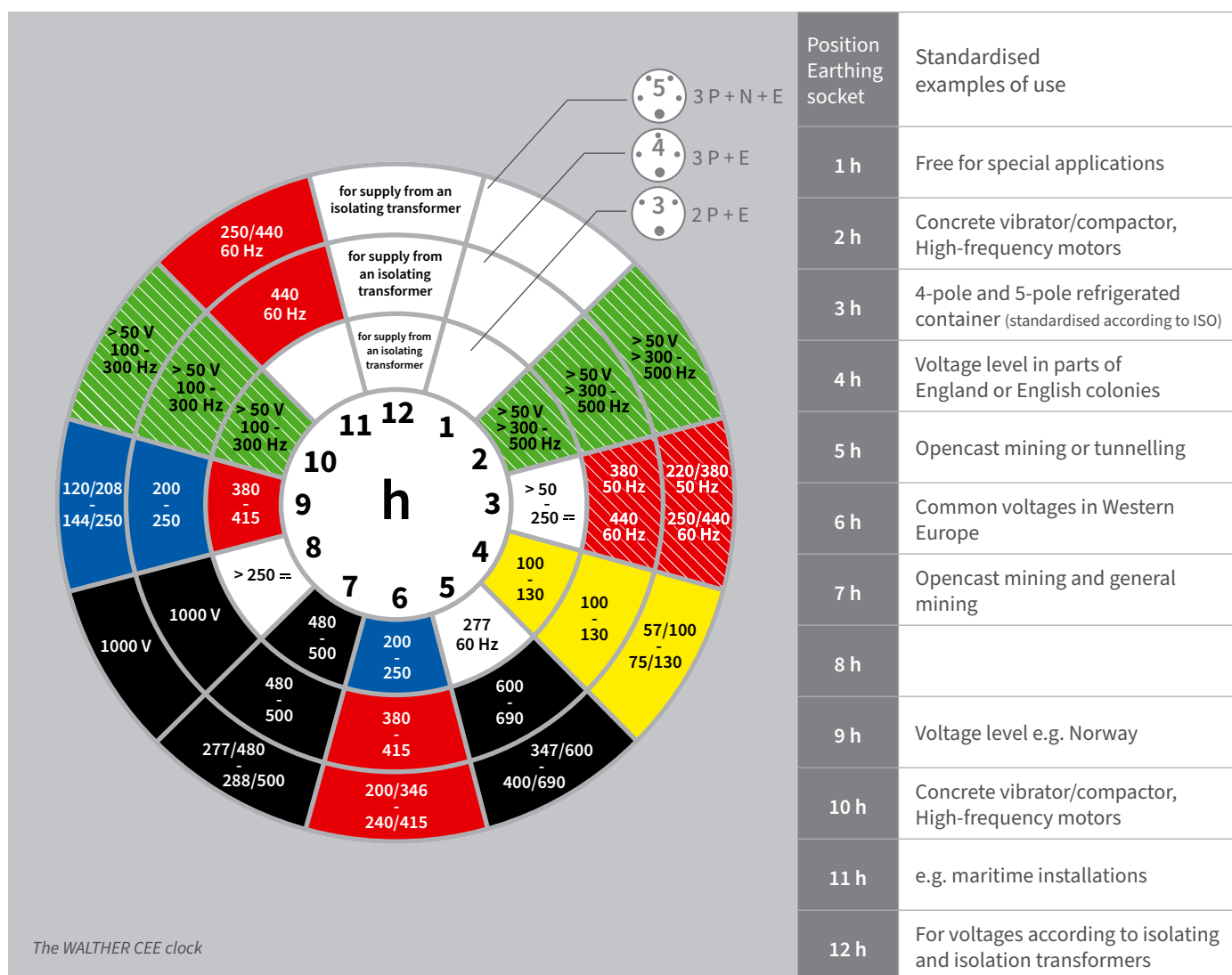

NEO – THE EVOLUTION OF CEE PLUGS & SOCKET DEVICES

USER-FRIENDLY ERGONOMICS

- Less expenditure of energy
- Simple & safe operation

DUST & SPLASH PROTECTION

- Increased standard protection category IP54

ROBUST MATERIAL

- Housing made of PA66 material guarantees high stability
- High-heat resistant contact carriers

SCREW-FREE HOUSING OPENING

QR CODE

- Quick access to current product information and assembly instructions

SAFE & MAINTENANCE-FREE CONNECTION TECHNOLOGY

ONE-TOUCH CLOSURE SYSTEM

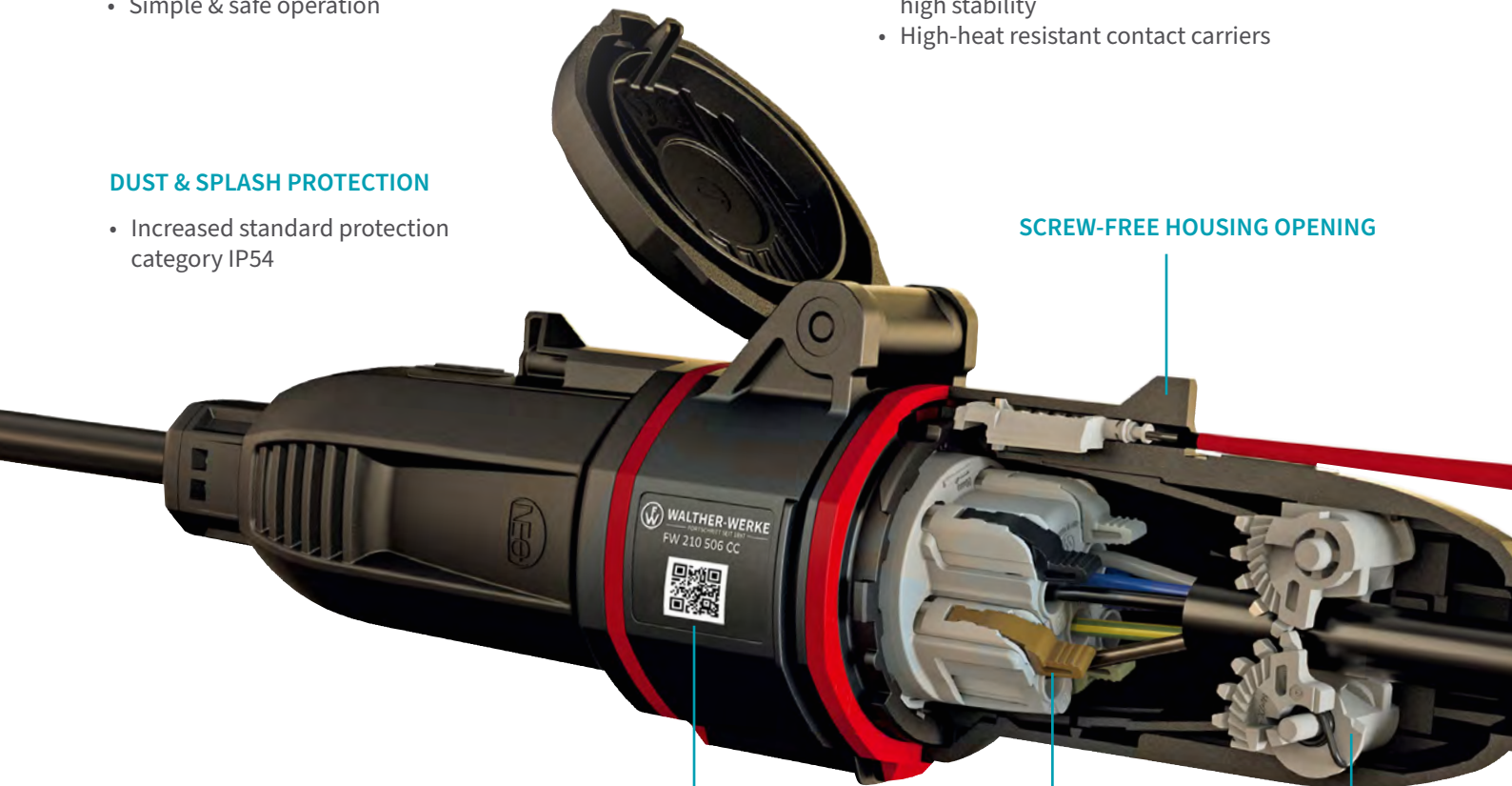

Our range of CEE plugs and sockets is suitable for different areas of application: for industrial applications, in construction and for the event and leisure sector. Depending on the requirements, we offer the right solution.

Thanks to optimised functionalities, NEO offers maximum user benefit.



PRODUCT HIGHLIGHTS

Screw-free housing opening

A push on the locking mechanism releases the connection between the front and rear parts of the plug.

One-Touch closure system

Two work steps combined in a 1/4 turn:

1. Connection of front and rear part of the plug
2. Automatic activation of the internal strain relief

Safe & maintenance-free connection technology

- Screw-free & convenient operation through connection terminal lever (CAGE CLAMP®) from WAGO®. Frequent reconnectability and time saving during assembly.
- Screw contact with Torx screws for optimum power transmission and increased service life.

EASY TO INSTALL. INTUITIVE. FLEXIBLE.

Simple and flexible
cable entry



eClip easy cable entry through
hinged threaded connector

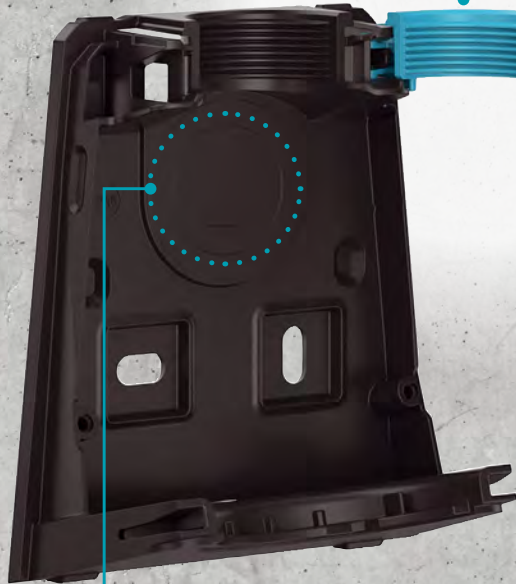

Intuitive housing
opening and easy
operation

Easy installation and
cable handling

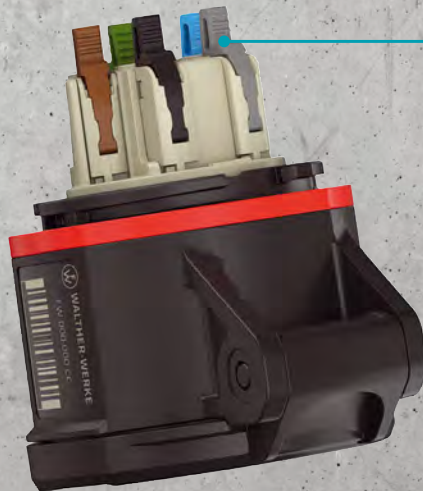

Shortened wiring time
thanks to maintenance-free
spring clamp technology
(CAGE CLAMP® by WAGO®)
and flexibility in the choice
of copper conductors.



WALTHER-WERKE

FORTSCHRITT SEIT 1897

walther-electric.co.uk

NEO



WALTHER-WERKE
FORTSCHRITT SEIT 1897

NEO

| | | | |  FW110306CC | |  FW110506SK | |  FW211306CC | |  FW211506SK | |  FW311306CC | |
|-----|--------|-----|----------------|---|--------|---|--------|--|--------|---|--------|---|--------|
| | | | | Wall Skt Screwless Version | | Wall Skt Screw Version | | Neo Plug Screwless | | Neo Plug Screw | | Neo Coupler Screwless | |
| Amp | Pole | ± | Volt | Ref No. | Trade | Ref No. | Trade | Ref No. | Trade | Ref No. | Trade | Ref No. | Trade |
| 16 | 2P+E | 4h | 110/130 | FW110304CC | £22.95 | FW110304SK | £21.95 | FW211304CC | £9.95 | FW211304SK | £8.70 | FW311304CC | £14.45 |
| 16 | 2P+E | 6h | 220/250 | FW110306CC | £22.95 | FW110306SK | £21.95 | FW211306CC | £9.95 | FW211306SK | £8.70 | FW311306CC | £14.45 |
| 16 | 2P+E | 9h | 380/415 | FW110309CC | POA | FW110309SK | POA | FW211309CC | POA | FW211309SK | POA | FW311309CC | £- |
| 16 | 3P+E | 4h | 110/130 | FW110404CC | POA | | | FW211404CC | POA | | | FW311404CC | £- |
| 16 | 3P+E | 9h | 220/250 | FW110409CC | POA | | | FW211409CC | POA | | | FW311409CC | £- |
| 16 | 3P+E | 6 | 380/415 | FW110406CC | £27.45 | | | FW211406CC | £20.85 | | | FW311406CC | £26.35 |
| 16 | 3P+E | 10h | >50v 100/300hz | FW110410CC | POA | | | FW211410CC | POA | | | FW311410CC | £- |
| 16 | 3P+N+E | 4h | 110/130 | FW110504CC | POA | FW110504SK | POA | FW211504CC | POA | FW211504SK | POA | FW311504CC | £- |
| 16 | 3P+N+E | 9h | 220/250 | FW110509CC | POA | FW110509SK | POA | FW211509CC | POA | FW211509SK | POA | FW311509CC | £- |
| 16 | 3P+N+E | 6h | 380/415 | FW110506CC | £32.35 | FW110506SK | £30.95 | FW211506CC | £22.85 | FW211506SK | £21.80 | FW311506CC | £29.65 |
| 16 | 3P+N+E | 6h | phase inverter | | | | | | | FW211506PH | POA | | |
| 32 | 2P+E | 4h | 110/130 | FW130304CC | £36.25 | FW130304SK | £34.60 | FW231304CC | £27.45 | FW231304SK | £26.20 | FW331304CC | £32.95 |
| 32 | 2P+E | 6h | 220/250 | FW130306CC | £35.15 | FW130306SK | £33.55 | FW231306CC | £27.45 | FW231306SK | £26.20 | FW331306CC | £32.95 |
| 32 | 2P+E | 9h | 380/415 | FW130309CC | POA | FW130309SK | POA | FW231309CC | POA | FW231309SK | POA | FW331309CC | £- |
| 32 | 3P+E | 4h | 110/130 | FW130404CC | POA | | | FW231404CC | POA | | | FW331404CC | £- |
| 32 | 3P+E | 9h | 220/250 | FW130409CC | POA | | | FW231409CC | POA | | | FW331409CC | £- |
| 32 | 3P+E | 6h | 380/415 | FW130406CC | £39.75 | | | FW231406CC | £28.90 | | | FW331406CC | £36.25 |
| 32 | 3P+E | 10h | >50v 100/300hz | FW130404CC | POA | | | FW231410CC | POA | | | FW331410CC | £- |
| 32 | 3P+N+E | 4h | 110/130 | FW130504CC | POA | FW130504SK | POA | FW231504CC | POA | FW231504SK | POA | FW331504CC | £- |
| 32 | 3P+N+E | 9h | 220/250 | FW130509CC | POA | FW130509SK | POA | FW231509CC | POA | FW231509SK | POA | FW331509CC | £- |
| 32 | 3P+N+E | 6h | 380/415 | FW130506CC | £46.15 | FW130506SK | £43.95 | FW231506CC | £29.65 | FW231506SK | £28.30 | FW331506CC | £39.30 |
| 32 | 3P+N+E | 6h | Phase Inverter | | | | | | | FW231506PH | POA | | |

NEO

| | | | |  FW131306CC | |  FW131306SK | |  FW230506CC | |  FW210506BT | |  FW330506CC | |
|-----|--------|-----|----------------|---|--------|---|--------|--|-------|---|-------|---|-------|
| | | | | Wall Skt Screwless Dual Entry | | Wall Skt Screw Dual Entry | | Neo Plug One Touch | | | | Neo Coupler One Touch | |
| Amp | Pole | ± | Volt | Ref No. | Trade | Ref No. | Trade | Ref No. | Trade | Ref No. | Trade | Ref No. | Trade |
| 16 | 2P+E | 4h | 110/130 | FW111304CC | £34.85 | FW111304SK | £32.95 | | | | | | |
| 16 | 2P+E | 6h | 220/250 | FW111306CC | £34.45 | FW111306SK | £32.60 | | | | | | |
| 16 | 2P+E | 9h | 380/415 | FW111309CC | POA | FW111309SK | POA | | | | | | |
| 16 | 3P+E | 4h | 110/130 | FW111404CC | POA | | | FW210404CC | | | | | |
| 16 | 3P+E | 9h | 220/250 | FW111409CC | POA | | | FW210409CC | | | | | |
| 16 | 3P+E | 6 | 380/415 | FW111406CC | £31.20 | | | FW210406CC | | | | | |
| 16 | 3P+E | 10h | >50v 100/300hz | FW111410CC | POA | | | FW210410CC | | | | | |
| 16 | 3P+N+E | 4h | 110/130 | FW111504CC | POA | FW111504SK | POA | FW210504CC | POA | | | FW310504CC | POA |
| 16 | 3P+N+E | 9h | 220/250 | FW111509CC | POA | FW111509SK | POA | FW210509CC | POA | | | FW310509CC | POA |
| 16 | 3P+N+E | 6h | 380/415 | FW111506CC | £34.95 | FW111506SK | £33.35 | FW210506CC | POA | | | FW310506CC | POA |
| 16 | 3P+N+E | 6h | phase inverter | | | | | | | FW210506BT | | | |
| 32 | 2P+E | 4h | 110/130 | FW131304CC | £48.95 | FW131304SK | £46.75 | | | | | | |
| 32 | 2P+E | 6h | 220/250 | FW131306CC | £47.45 | FW131306SK | £45.30 | | | | | | |
| 32 | 2P+E | 9h | 380/415 | FW131309CC | POA | FW131309SK | POA | | | | | | |
| 32 | 3P+E | 4h | 110/130 | FW131404CC | POA | | | FW230404CC | | | | | |
| 32 | 3P+E | 9h | 220/250 | FW131409CC | POA | | | FW230409CC | | | | | |
| 32 | 3P+E | 6h | 380/415 | FW131406CC | £52.35 | | | FW230406CC | | | | | |
| 32 | 3P+E | 10h | >50v 100/300hz | FW131404CC | POA | | | FW230410CC | | | | | |
| 32 | 3P+N+E | 4h | 110/130 | FW131504CC | POA | FW131504SK | POA | FW230504CC | POA | | | FW330504CC | POA |
| 32 | 3P+N+E | 9h | 220/250 | FW131509CC | POA | FW131509SK | POA | FW230509CC | POA | | | FW330509CC | POA |
| 32 | 3P+N+E | 6h | 380/415 | FW131506CC | £52.25 | FW131506SK | £49.90 | FW230506CC | POA | | | FW330506CC | POA |
| 32 | 3P+N+E | 6h | Phase Inverter | | | | | | | | | | |

NEO

| | | | |  | | |  | | |  | | |  | | |  |
|-----|--------|-----|----------------|---|--------|------------------------|---|--------------------|--------|--|--------|-----------------------|---|--|--|---|
| | | | | FW311506SK | | FW411306CC | | FW411506CC | | FW710306CC | | FW730506SK | | | | |
| | | | | Neo Coupler Screw | | Panel Socket Screwless | | Panel Socket Screw | | Appliance inlet screwless | | Appliance inlet screw | | | | |
| Amp | Pole | ± | Volt | Ref No. | Trade | Ref No. | Trade | Ref No. | Trade | Ref No. | Trade | Ref No. | Trade | | | |
| 16 | 2P+E | 4h | 110/130 | FW311304SK | £13.80 | FW412304CC | £14.60 | FW412304SK | £13.90 | FW710304CC | £28.55 | FW710304SK | £27.25 | | | |
| 16 | 2P+E | 6h | 220/250 | FW311306SK | £13.80 | FW412306CC | £14.60 | FW412306SK | £13.90 | FW710306CC | £28.55 | FW710306SK | £27.25 | | | |
| 16 | 2P+E | 9h | 380/415 | FW311309SK | POA | FW412309CC | POA | FW412309SK | POA | FW710309CC | POA | FW710309SK | £- | | | |
| 16 | 3P+E | 4h | 110/130 | | | FW410404CC | POA | | | FW710404CC | POA | | | | | |
| 16 | 3P+E | 9h | 220/250 | | | FW410409CC | POA | | | FW710409CC | POA | | | | | |
| 16 | 3P+E | 6 | 380/415 | | | FW410406CC | £25.25 | | | FW710406CC | £36.25 | | | | | |
| 16 | 3P+E | 10h | >50v 100/300hz | | | FW410410CC | POA | | | FW710410CC | POA | | | | | |
| 16 | 3P+N+E | 4h | 110/130 | FW311504SK | POA | FW410504CC | POA | FW410504SK | POA | FW710504CC | POA | FW710504CC | POA | | | |
| 16 | 3P+N+E | 9h | 220/250 | FW311509SK | POA | FW410509CC | POA | FW410509SK | POA | FW710509CC | POA | FW710509SK | POA | | | |
| 16 | 3P+N+E | 6h | 380/415 | FW311506SK | £28.30 | FW410506CC | £28.55 | FW410506SK | £27.25 | FW710506CC | £31.45 | FW710506SK | £29.95 | | | |
| 16 | 3P+N+E | 6h | phase inverter | | | | | | | | | FW710506PH | POA | | | |
| 32 | 2P+E | 4h | 110/130 | FW331304SK | £31.45 | FW430304CC | £31.85 | FW430304SK | £30.40 | FW730304CC | £42.85 | FW730304SK | £40.90 | | | |
| 32 | 2P+E | 6h | 220/250 | FW331306SK | £31.45 | FW430306CC | £31.85 | FW430306SK | £30.40 | FW730306CC | £42.85 | FW730306SK | £40.90 | | | |
| 32 | 2P+E | 9h | 380/415 | FW331309SK | POA | FW430309CC | POA | FW430309SK | POA | FW730309CC | POA | FW730309SK | POA | | | |
| 32 | 3P+E | 4h | 110/130 | | | FW430404CC | POA | | | FW730404CC | POA | | | | | |
| 32 | 3P+E | 9h | 220/250 | | | FW430409CC | POA | | | FW730409CC | POA | | | | | |
| 32 | 3P+E | 6h | 380/415 | | | FW430406CC | £37.35 | | | FW730406CC | £49.45 | | | | | |
| 32 | 3P+E | 10h | >50v 100/300hz | | | FW430410CC | POA | | | FW730410CC | POA | | | | | |
| 32 | 3P+N+E | 4h | 110/130 | FW331504SK | POA | FW430504CC | POA | FW430504SK | POA | FW730504CC | POA | FW730504SK | POA | | | |
| 32 | 3P+N+E | 9h | 220/250 | FW331509SK | POA | FW430509CC | POA | FW430509SK | POA | FW730509CC | POA | FW730509SK | POA | | | |
| 32 | 3P+N+E | 6h | 380/415 | FW331506SK | £37.55 | FW430506CC | £41.65 | FW430506SK | £39.75 | FW730506CC | £53.85 | FW730506SK | £51.40 | | | |
| 32 | 3P+N+E | 6h | Phase Inverter | | | | | | | | | FW730506PH | POA | | | |

NEO

| | | | |  | | |  | | |  | | |  |
|-----|--------|-----|----------------|---|-------|----------------------|---|----------------------------|--------|---|--------|--|---|
| | | | | FW510506CC | | FW510506SK | | FW610306CC | | FW610506SK | | | |
| | | | | Angled Pnl/Skt Screwless | | Angled Pnl/Skt Screw | | St Pnl/App Inlet screwless | | St Pnl/App Inlet screw | | | |
| Amp | Pole | ± | Volt | Ref No. | Trade | Ref No. | Trade | Ref No. | Trade | Ref No. | Trade | | |
| 16 | 2P+E | 4h | 110/130 | FW510304CC | POA- | FW510304SK | POA- | FW610304CC | POA- | FW610304SK | POA- | | |
| 16 | 2P+E | 6h | 220/250 | FW510306CC | POA | FW510306SK | POA | FW610306CC | POA | FW610306SK | POA | | |
| 16 | 2P+E | 9h | 380/415 | FW510309CC | POA | FW510309SK | POA | FW610309CC | POA | FW610309SK | POA | | |
| 16 | 3P+E | 4h | 110/130 | FW510404CC | POA | | | FW610404CC | POA | | | | |
| 16 | 3P+E | 9h | 220/250 | FW510409CC | POA | | | FW610409CC | POA | | | | |
| 16 | 3P+E | 6 | 380/415 | FW510406CC | POA | | | FW610406CC | £24.15 | | | | |
| 16 | 3P+E | 10h | >50v 100/300hz | FW510410CC | POA | | | FW610410CC | POA | | | | |
| 16 | 3P+N+E | 4h | 110/130 | FW510504CC | POA- | FW510504SK | POA- | FW610504CC | POA- | FW610504SK | POA- | | |
| 16 | 3P+N+E | 9h | 220/250 | FW510509CC | POA | FW510509SK | POA | FW610509CC | POA | FW610509SK | POA | | |
| 16 | 3P+N+E | 6h | 380/415 | FW510506CC | POA | FW510506SK | POA | FW610506CC | £26.95 | FW610506SK | £25.70 | | |
| 16 | 3P+N+E | 6h | phase inverter | | POA | | POA | | | FW610506PH | POA | | |
| 32 | 2P+E | 4h | 110/130 | FW530304CC | POA | FW530304SK | POA | FW630304CC | £30.40 | FW630304SK | £28.95 | | |
| 32 | 2P+E | 6h | 220/250 | FW530306CC | POA | FW530306SK | POA | FW630306CC | £30.40 | FW630306SK | £28.95 | | |
| 32 | 2P+E | 9h | 380/415 | FW530309CC | POA | FW530309SK | POA | FW630309CC | POA | FW630309SK | POA | | |
| 32 | 3P+E | 4h | 110/130 | FW530404CC | POA- | | | FW630404CC | POA- | | | | |
| 32 | 3P+E | 9h | 220/250 | FW530409CC | POA | | | FW630409CC | POA | | | | |
| 32 | 3P+E | 6h | 380/415 | FW530406CC | POA | | | FW630406CC | £31.60 | | | | |
| 32 | 3P+E | 10h | >50v 100/300hz | FW530410CC | POA | | | FW630410CC | POA | | | | |
| 32 | 3P+N+E | 4h | 110/130 | FW530504CC | POA | FW530504SK | POA | FW630504CC | POA | FW630504SK | POA | | |
| 32 | 3P+N+E | 9h | 220/250 | FW530509CC | POA | FW530509SK | POA | FW630509CC | POA | FW630509SK | POA | | |
| 32 | 3P+N+E | 6h | 380/415 | FW530506CC | POA | FW530506SK | POA | FW630506CC | £36.95 | FW630506SK | £34.95 | | |
| 32 | 3P+N+E | 6h | Phase Inverter | | | | | | | FW630506PH | POA | | |

PLUGS







| | | | | Long Grommet style plugs IP44 | | Plug Compression Cable Entry IP44 | | Plug Gland Entry IP44 | | Right Angled IP44 | | Watertight IP67 | |
|-----|--------|-----|----------------|-------------------------------|---------|-----------------------------------|---------|-----------------------|---------|-------------------|--------|-----------------|---------|
| Amp | Pole | ± | Volt | Ref No. | Trade | Ref No. | Trade | Ref No. | Trade | Ref No. | Trade | Ref No. | Trade |
| 16 | 2P+E | 4h | 110/130 | 210304 | £8.30 | | | 211304 | £14.20 | 216304 | £38.95 | 219304 | £28.45 |
| 16 | 2P+E | 6h | 220/250 | 210306 | £8.30 | | | 211306 | £14.95 | 216306 | £23.75 | 219306 | £28.45 |
| 16 | 2P+E | 9h | 380/415 | 210309 | £21.25 | | | 211309 | £23.95 | 216309 | £45.10 | 219309 | £85.70 |
| 16 | 3P+E | 4h | 110/130 | | | 210404 | £21.95 | 211404 | £38.15 | 216404 | £56.95 | 219404 | £47.25 |
| 16 | 3P+E | 9h | 220/250 | | | 210409 | £23.75 | 211409 | £42.50 | 216409 | £56.95 | 219409 | £46.95 |
| 16 | 3P+E | 6h | 380/415 | | | 210406 | £18.95 | 211406 | £35.70 | 216406 | £48.90 | 219406 | £41.95 |
| 16 | 3P+E | 10h | >50v 100/300hz | | | 210410 | £33.75 | 211410 | £40.85 | 216410 | POA | 219410 | £66.70 |
| 16 | 3P+N+E | 4h | 110/130 | | | 210504 | £24.95 | 211504 | £50.15 | 216504 | £65.30 | 219504 | £81.30 |
| 16 | 3P+N+E | 9h | 220/250 | | | 210509 | £24.95 | 211509 | £50.15 | 216509 | £65.30 | 219509 | £81.30 |
| 16 | 3P+N+E | 6h | 380/415 | | | 210 | £20.75 | 211 | £22.95 | 216 | £33.45 | 219 | £42.90 |
| 16 | 3P+N+E | 6h | phase inverter | | | 210PH | £53.50 | 211PH | POA | | | | |
| 16 | 6P+E | 9h | 220/250 | 210709 | £105.95 | | | 211709 | POA | | | | |
| 16 | 6P+E | 6h | 380/415 | 210706 | £70.35 | | | 211706 | POA | | | | |
| 32 | 2P+E | 4h | 110/130 | | | 230304 | £24.95 | 231304 | £39.70 | 236304 | £73.25 | 239304 | £48.95 |
| 32 | 2P+E | 6h | 220/250 | | | 230306 | £24.95 | 231306 | £33.55 | 236306 | £46.80 | 239306 | £48.95 |
| 32 | 2P+E | 9h | 380/415 | | | 230309 | £52.25 | 231309 | £69.95 | 236309 | £89.50 | 239309 | £100.95 |
| 32 | 3P+E | 4h | 110/130 | | | 230404 | £34.95 | 231404 | £60.40 | 236404 | £89.50 | 239404 | £97.40 |
| 32 | 3P+E | 9h | 220/250 | | | 230409 | £34.95 | 231409 | £36.95 | 236409 | £81.70 | 239409 | £106.05 |
| 32 | 3P+E | 6h | 380/415 | | | 230406 | £26.25 | 231406 | £35.20 | 236406 | £55.55 | 239406 | £55.60 |
| 32 | 3P+E | 10h | >50v 100/300hz | | | 230410 | £44.95 | 231410 | £63.20 | 236410 | POA | 239410 | £102.95 |
| 32 | 3P+E | 3h | 440/container | | | | | | | | | 239403 | £58.70 |
| 32 | 3P+N+E | 4h | 110/130 | | | 230504 | £51.95 | 231504 | £71.00 | 236504 | £89.50 | 239504 | £79.80 |
| 32 | 3P+N+E | 9h | 220/250 | | | 230509 | £37.75 | 231509 | £71.00 | 236509 | £89.50 | 239509 | £88.35 |
| 32 | 3P+N+E | 6h | 380/415 | | | 230 | £26.95 | 231 | £29.65 | 236 | £69.90 | 239 | £56.70 |
| 32 | 3P+N+E | 6h | Phase Inverter | | | 230PH | £63.85 | 231PH | POA | | | | |
| 32 | 6P+E | 9h | 220/250 | 230709 | £121.95 | | | 231709 | POA | | | | |
| 32 | 6P+E | 6h | 380/415 | 230706 | £86.95 | | | 231706 | POA | | | | |
| 63 | 2P+E | 4h | 110/130 | 260304 | £117.40 | 262304 | £95.55 | 261304 | £95.55 | | | 269304 | £115.45 |
| 63 | 2P+E | 6h | 220/250 | 260306 | £117.40 | 262306 | £83.95 | 261306 | £83.95 | | | 269306 | £94.95 |
| 63 | 2P+E | 9h | 380/415 | 260309 | POA | 262309 | POA | 261309 | £135.20 | | | 269309 | £128.30 |
| 63 | 3P+E | 4h | 110/130 | 260404 | POA | 262404 | POA | 261404 | £113.80 | | | 269404 | £126.85 |
| 63 | 3P+E | 9h | 220/250 | 260409 | £149.90 | 262409 | £149.90 | 261409 | £113.80 | | | 269409 | £122.95 |
| 63 | 3P+E | 6h | 380/415 | 260406 | £124.95 | 262406 | £87.95 | 261406 | £87.95 | | | 269406 | £96.95 |
| 63 | 3P+N+E | 4h | 110/130 | 260504 | £159.90 | 262504 | POA | 261504 | £117.85 | | | 269504 | £137.95 |
| 63 | 3P+N+E | 9h | 220/250 | 260509 | £159.90 | 262509 | £159.90 | 261509 | £117.85 | | | 269509 | £137.95 |
| 63 | 3P+N+E | 6h | 380/415 | 260 | £135.10 | 262 | £86.30 | 261 | £86.30 | | | 269 | £99.95 |
| 125 | 2P+E | 4h | 110/130 | | | | | | | | | 279304 | £317.95 |
| 125 | 2P+E | 6h | 220/250 | | | | | | | | | 279306 | £278.95 |
| 125 | 2P+E | 9h | 380/415 | | | | | | | | | 279309 | £379.45 |
| 125 | 3P+E | 4h | 110/130 | | | | | | | | | 279404 | £456.60 |
| 125 | 3P+E | 9h | 220/250 | | | | | | | | | 279409 | £458.15 |
| 125 | 3P+E | 6h | 380/415 | | | | | | | | | 279406 | £299.95 |
| 125 | 3P+N+E | 4h | 110/130 | | | | | | | | | 279504 | £472.20 |
| 125 | 3P+N+E | 9h | 220/250 | | | | | | | | | 279509 | £488.30 |
| 125 | 3P+N+E | 6h | 380/415 | | | | | | | | | 279 | £307.70 |



| | | | | Grommet Entry IP44 | | Plug Gland Entry IP44 | | Grommet Entry IP44 | | Gland Entry IP44 | | Long clear plugs | | | |
|-----|------|----|------|--------------------|--------|-----------------------|--------|--------------------|--------|------------------|--------|----------------------|------|----------|--------|
| Amp | Pole | ± | Volt | Ref No. | Trade | Ref No. | Trade | Ref No. | Trade | Ref No. | Trade | Amp | Pole | Ref No. | Trade |
| 16 | 2 | - | 24 | 10280 | £32.50 | 10220 | £40.50 | 10380 | £34.30 | 10320 | £43.30 | 16 | 2P+E | 210304CL | POA |
| 16 | 2 | 12 | 42 | 10281 | £32.50 | 10221 | £40.50 | 10381 | £43.85 | 10321 | £48.70 | 16 | 2P+E | 210306CL | POA |
| 16 | 3 | - | 24 | 10290 | £31.95 | 10260 | £59.40 | 10390 | £43.65 | 10360 | £43.80 | Inverted Clear plugs | | | |
| 16 | 3 | 12 | 42 | 10291 | £39.50 | 10261 | £40.35 | 10391 | £44.25 | 10361 | £47.75 | 16 | 2P+E | 215304CL | POA |
| 32 | 2 | - | 24 | 11280 | £41.35 | 11220 | £42.80 | 11380 | £53.45 | 11320 | £48.70 | 16 | 2P+E | 215306CL | POA |
| 32 | 2 | 12 | 42 | 11281 | £41.35 | 11221 | £42.80 | 11381 | £53.45 | 11321 | £48.70 | Inverted Grey plugs | | | |
| 32 | 3 | - | 24 | 11290 | £39.20 | 11260 | £48.70 | 11390 | £53.45 | 11360 | £43.85 | 16 | 2P+E | 215304 | £12.50 |
| 32 | 3 | 12 | 42 | 11291 | £39.20 | 11261 | £48.70 | 11391 | £53.35 | 11361 | £43.85 | 16 | 2P+E | 215306 | £13.20 |

COUPLERS

| | | | |  310306 |  310 |  311 |  319 | | | | |
|-----|--------|-----|----------------|--|---|---|---|---------|---------|---------|---------|
| | | | | Long Grommet style couplers IP44 | Coupler Compression Cable Entry IP44 | Glanded couplers IP44 | Watertight couplers IP67 | | | | |
| Amp | Pole | ± | Volt | Ref No. | Trade | Ref No. | Trade | Ref No. | Trade | Ref No. | Trade |
| 16 | 2P+E | 4h | 110/130 | 310304 | £13.15 | | | 311304 | £17.85 | 319304 | £34.25 |
| 16 | 2P+E | 6h | 220/250 | 310306 | £13.15 | | | 311306 | £17.85 | 319306 | £33.95 |
| 16 | 2P+E | 9h | 380/415 | 310309 | £39.95 | | | 311309 | £47.85 | 319309 | £59.75 |
| 16 | 3P+E | 4h | 110/130 | | | 310404 | £29.95 | 311404 | £46.40 | 319404 | £57.95 |
| 16 | 3P+E | 9h | 220/250 | | | 310409 | £29.95 | 311409 | £49.70 | 319409 | £53.20 |
| 16 | 3P+E | 6h | 380/415 | | | 310406 | £23.95 | 311406 | £31.15 | 319406 | £48.95 |
| 16 | 3P+E | 10h | >50v 100/300hz | | | 310410 | £40.15 | 311410 | £53.95 | 319410 | £65.15 |
| 16 | 3P+N+E | 4h | 110/130 | | | 310504 | £51.70 | 311504 | £69.45 | 319504 | £109.55 |
| 16 | 3P+N+E | 9h | 220/250 | | | 310509 | £35.50 | 311509 | £69.45 | 319509 | £109.55 |
| 16 | 3P+N+E | 6h | 380/415 | | | 310 | £26.95 | 311 | £29.15 | 319 | £49.95 |
| 16 | 3P+N+E | 6h | phase inverter | | | | | | | | |
| 16 | 6P+E | 9h | 220/250 | 310709 | £118.95 | | | 311709 | POA | | |
| 16 | 6P+E | 6h | 380/415 | 310706 | £116.50 | | | 311706 | POA | | |
| 32 | 2P+E | 4h | 110/130 | | | 330304 | £29.95 | 331304 | £39.95 | 339304 | £54.95 |
| 32 | 2P+E | 6h | 220/250 | | | 330306 | £29.95 | 331306 | £33.10 | 339306 | £54.95 |
| 32 | 2P+E | 9h | 380/415 | | | 330309 | £69.45 | 331309 | £73.35 | 339309 | £133.80 |
| 32 | 3P+E | 4h | 110/130 | | | 330404 | £58.45 | 331404 | £66.65 | 339404 | £168.75 |
| 32 | 3P+E | 9h | 220/250 | | | 330409 | £41.95 | 331409 | £69.95 | 339409 | £119.50 |
| 32 | 3P+E | 6h | 380/415 | | | 330406 | £32.95 | 331406 | £47.45 | 339406 | £59.95 |
| 32 | 3P+E | 10h | >50v 100/300hz | | | 330410 | £56.45 | 331410 | £64.25 | 339410 | £97.45 |
| 32 | 3P+E | 3h | 440/container | | | | | | | 339403 | £69.95 |
| 32 | 3P+N+E | 4h | 110/130 | | | 330504 | £59.95 | 331504 | £85.30 | 339504 | £149.95 |
| 32 | 3P+N+E | 9h | 220/250 | | | 330509 | £46.50 | 331509 | £85.30 | 339509 | £149.95 |
| 32 | 3P+N+E | 6h | 380/415 | | | 330 | £35.75 | 331 | £39.75 | 339 | £64.95 |
| 32 | 3P+N+E | 6h | Phase Inverter | | | | | | | | |
| 32 | 6P+E | 9h | 220/250 | 330709 | £142.95 | | | 331709 | POA | | |
| 32 | 6P+E | 6h | 380/415 | 330706 | £102.95 | | | 331706 | POA | | |
| 63 | 2P+E | 4h | 110/130 | 360304 | POA | 362304 | £97.95 | 361304 | £97.95 | 369304 | £115.95 |
| 63 | 2P+E | 6h | 220/250 | 360306 | £165.60 | 362306 | £96.95 | 361306 | £96.95 | 369306 | £105.95 |
| 63 | 2P+E | 9h | 380/415 | 360309 | POA | 362309 | POA | 361309 | £156.70 | 369309 | £125.90 |
| 63 | 3P+E | 4h | 110/130 | 360404 | £158.45 | 362404 | POA | 361404 | £132.95 | 369404 | £144.35 |
| 63 | 3P+E | 9h | 220/250 | 360409 | £158.45 | 362409 | £158.45 | 361409 | £132.95 | 369409 | £144.00 |
| 63 | 3P+E | 6h | 380/415 | 360406 | £149.90 | 362406 | £103.95 | 361406 | £103.95 | 369406 | £118.95 |
| 63 | 3P+N+E | 4h | 110/130 | 360504 | £174.20 | 362504 | POA | 361504 | £146.65 | 369504 | £153.95 |
| 63 | 3P+N+E | 9h | 220/250 | 360509 | £174.20 | 362509 | £174.20 | 361509 | £146.65 | 369509 | £153.95 |
| 63 | 3P+N+E | 6h | 380/415 | 360 | £165.60 | 362 | £108.95 | 361 | £108.95 | 369 | £120.75 |
| 125 | 2P+E | 4h | 110/130 | | | | | | | 379304 | £389.95 |
| 125 | 2P+E | 6h | 220/250 | | | | | | | 379306 | £338.25 |
| 125 | 2P+E | 9h | 380/415 | | | | | | | 379309 | £464.20 |
| 125 | 3P+E | 4h | 110/130 | | | | | | | 379404 | £459.95 |
| 125 | 3P+E | 9h | 220/250 | | | | | | | 379409 | £467.50 |
| 125 | 3P+E | 6h | 380/415 | | | | | | | 379406 | £377.95 |
| 125 | 3P+N+E | 4h | 110/130 | | | | | | | 379504 | £477.95 |
| 125 | 3P+N+E | 9h | 220/250 | | | | | | | 379509 | £477.95 |
| 125 | 3P+N+E | 6h | 380/415 | | | | | | | 379 | £379.10 |



| | | | | Low Voltage Wall Sockets | | | | Low Voltage Panel Sockets | | | | Low voltage Appliance inlet | | | |
|-----|------|----|------|--------------------------|--------|--------------------|-------|---------------------------|--------|-------------|--------|-----------------------------|--------|---------|-------|
| | | | | Top Entry IP44 | | Various Entry IP44 | | Straight IP44 | | Angled IP44 | | Surface mount IP44 | | | |
| Amp | Pole | ± | Volt | Ref No. | Trade | Ref No. | Trade | Ref No. | Trade | Ref No. | Trade | Ref No. | Trade | Ref No. | Trade |
| 16 | 2 | - | 24 | 10110 | £38.85 | 10100 | POA | 10400 | £34.95 | 10500 | £37.70 | 10800 | £48.70 | | |
| 16 | 2 | 12 | 42 | 10111 | £41.50 | 10101 | POA | 10401 | £34.95 | 10501 | £37.70 | 10801 | £48.70 | | |
| 16 | 3 | - | 24 | 10150 | £42.95 | 10140 | POA | 10440 | £38.95 | 10540 | £47.15 | 10840 | £42.95 | | |
| 16 | 3 | 12 | 42 | 10151 | £51.10 | 10141 | POA | 10441 | POA | 10541 | POA | 10841 | £53.45 | | |
| 32 | 2 | - | 24 | 11110 | £53.10 | 11100 | POA | 11400 | £49.85 | 11500 | POA | 11800 | £63.25 | | |
| 32 | 2 | 12 | 42 | 11111 | £53.10 | 11101 | POA | 11401 | £38.95 | 11501 | POA | 11801 | £63.25 | | |
| 32 | 3 | - | 24 | 11150 | £46.85 | 11140 | POA | 11440 | £38.35 | 11540 | POA | 11840 | £63.25 | | |
| 32 | 3 | 12 | 42 | 11151 | £52.80 | 11141 | POA | 11441 | £38.95 | 11541 | POA | 11841 | £63.25 | | |

| | | | | Long clear couplers | | | |
|-------------------|------|----------|--------|---------------------|------|----------|--------|
| Amp | Pole | Ref No. | Trade | Amp | Pole | Ref No. | Trade |
| 16 | 2P+E | 310304CL | POA | 16 | 2P+E | 310306CL | POA |
| Inverted couplers | | | | | | | |
| 16 | 2P+E | 315304CL | POA | 16 | 2P+E | 315306CL | POA |
| Inverted couplers | | | | | | | |
| 16 | 2P+E | 315304 | £12.50 | 16 | 2P+E | 315306 | £13.20 |

PANEL SOCKETS

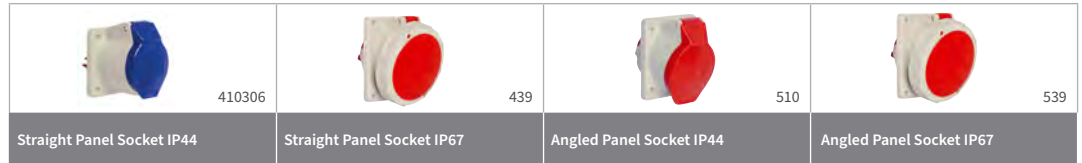

| | | | | Straight Panel Socket IP44 | | Straight Panel Socket IP67 | | Angled Panel Socket IP44 | | Angled Panel Socket IP67 | |
|-----|--------|-----|----------------|----------------------------|---------|----------------------------|---------|--------------------------|---------|--------------------------|---------|
| Amp | Pole | ± | Volt | Ref No. | Trade | Ref No. | Trade | Ref No. | Trade | Ref No. | Trade |
| 16 | 2P+E | 4h | 110/130 | 410304 | £13.25 | 419304 | £37.95 | 510304 | £16.95 | 519304 | £42.95 |
| 16 | 2P+E | 6h | 220/250 | 410306 | £13.25 | 419306 | £42.95 | 510306 | £16.95 | 519306 | £41.25 |
| 16 | 2P+E | 9h | 380/415 | 410309 | £39.30 | 419309 | £59.95 | 510309 | £44.10 | 519309 | £45.45 |
| 16 | 3P+E | 4h | 110/130 | 410404 | £29.30 | 419404 | £71.25 | 510404 | £44.10 | 519404 | £63.15 |
| 16 | 3P+E | 9h | 220/250 | 410409 | £37.95 | 419409 | £83.95 | 510409 | £32.25 | 519409 | £63.75 |
| 16 | 3P+E | 6h | 380/415 | 410406 | £22.95 | 419406 | £56.95 | 510406 | £26.75 | 519406 | £52.95 |
| 16 | 3P+E | 10h | >50v 100/300hz | 410410 | £41.95 | 419410 | £66.70 | 510410 | £44.95 | 519410 | £74.35 |
| 16 | 3P+N+E | 4h | 110/130 | 410504 | £46.80 | 419504 | £67.95 | 510504 | £52.95 | 519504 | £66.95 |
| 16 | 3P+N+E | 9h | 220/250 | 410509 | £46.80 | 419509 | £67.95 | 510509 | £52.95 | 519509 | £66.95 |
| 16 | 3P+N+E | 6h | 380/415 | 410 | £25.95 | 419 | £64.50 | 510 | £28.95 | 519 | £55.95 |
| 16 | 6P+E | 9h | 220/250 | 411709 | £109.20 | | | 510709 | POA | | |
| 16 | 6P+E | 6h | 380/415 | 411706 | £106.90 | | | 510706 | POA | | |
| 32 | 2P+E | 4h | 110/130 | 430304 | £28.95 | 439304 | £63.50 | 530304 | £32.95 | 539304 | £66.60 |
| 32 | 2P+E | 6h | 220/250 | 430306 | £28.95 | 439306 | £66.90 | 530306 | £32.95 | 539306 | £63.95 |
| 32 | 2P+E | 9h | 380/415 | 430309 | £51.55 | 439309 | £74.70 | 530309 | £59.60 | 539309 | £76.65 |
| 32 | 3P+E | 4h | 110/130 | 430404 | £41.95 | 439404 | £77.95 | 530404 | £58.80 | 539404 | £102.70 |
| 32 | 3P+E | 9h | 220/250 | 430409 | £41.95 | 439409 | £78.50 | 530409 | £58.50 | 539409 | £84.25 |
| 32 | 3P+E | 6h | 380/415 | 430406 | £33.95 | 439406 | £69.95 | 530406 | £35.95 | 539406 | £73.95 |
| 32 | 3P+E | 10h | >50v 100/300hz | 430410 | £53.20 | 439410 | £97.70 | 530410 | POA | 539410 | £119.95 |
| 32 | 3P+E | 3h | 440/container | | | 439403 | £67.95 | | | | |
| 32 | 3P+N+E | 4h | 110/130 | 430504 | £66.70 | 439504 | £97.70 | 530504 | £77.65 | 539504 | £100.55 |
| 32 | 3P+N+E | 9h | 220/250 | 430509 | £69.35 | 439509 | £97.00 | 530509 | £72.90 | 539509 | £100.55 |
| 32 | 3P+N+E | 6h | 380/415 | 430 | £37.85 | 439 | £76.95 | 530 | £38.95 | 539 | £75.95 |
| 32 | 6P+E | 9h | 220/250 | 431709 | £162.30 | | | 530709 | POA | | |
| 32 | 6P+E | 6h | 380/415 | 431706 | £127.50 | | | 530706 | POA | | |
| 63 | 2P+E | 4h | 110/130 | 460304 | £85.50 | 469304 | £122.95 | 560304 | £101.15 | 569304 | £118.95 |
| 63 | 2P+E | 6h | 220/250 | 460306 | £85.50 | 469306 | £122.95 | 560306 | £86.95 | 569306 | £118.95 |
| 63 | 2P+E | 9h | 380/415 | 460309 | POA | 469309 | POA | 560309 | POA | 569309 | POA |
| 63 | 3P+E | 4h | 110/130 | 460404 | £115.95 | 469404 | £142.95 | 560404 | £126.20 | 569404 | £170.35 |
| 63 | 3P+E | 9h | 220/250 | 460409 | £115.95 | 469409 | £145.95 | 560409 | £136.95 | 569409 | £170.35 |
| 63 | 3P+E | 6h | 380/415 | 460406 | £95.95 | 469406 | £106.25 | 560406 | £108.95 | 569406 | £114.50 |
| 63 | 3P+N+E | 4h | 110/130 | 460504 | £128.30 | 469504 | £159.95 | 560504 | £134.55 | 569504 | POA |
| 63 | 3P+N+E | 9h | 220/250 | 460509 | £117.95 | 469509 | £159.95 | 560509 | £134.55 | 569509 | £186.95 |
| 63 | 3P+N+E | 6h | 380/415 | 460 | £85.95 | 469 | £107.95 | 560 | £91.95 | 569 | £102.25 |
| 125 | 2P+E | 4h | 110/130 | | | 479304 | £391.95 | | | 579304 | £435.95 |
| 125 | 2P+E | 6h | 220/250 | | | 479306 | £392.95 | | | 579306 | £389.50 |
| 125 | 2P+E | 9h | 380/415 | | | 479309 | POA | | | 579309 | POA |
| 125 | 3P+E | 4h | 110/130 | | | 479404 | £437.35 | | | 579404 | £465.95 |
| 125 | 3P+E | 9h | 220/250 | | | 479409 | £394.95 | | | 579409 | £466.95 |
| 125 | 3P+E | 6h | 380/415 | | | 479406 | £394.95 | | | 579406 | £333.75 |
| 125 | 3P+N+E | 4h | 110/130 | | | 479504 | £505.75 | | | 579504 | £530.90 |
| 125 | 3P+N+E | 9h | 220/250 | | | 479509 | £505.75 | | | 579509 | £484.65 |
| 125 | 3P+N+E | 6h | 380/415 | | | 479 | £377.95 | | | 579 | £349.95 |

ALTERNATIVE VARIATIONS



| | | | | Large Flange IP44 | | Ceetyp Channel IP44 | | Mondo IP44 | | Mondo Channel IP44 | | 90° Panel Mount IP44 | | 90° Panel Mount IP67 | |
|-----|--------|----|---------|-------------------|--------|---------------------|-------|------------|--------|--------------------|---------|----------------------|--------|----------------------|--------|
| Amp | Pole | ± | Volt | Ref No. | Trade | Ref No. | Trade | Ref No. | Trade | Ref No. | Trade | Ref No. | Trade | Ref No. | Trade |
| 16 | 2P+E | 4h | 110/130 | 411304 | £17.95 | 412304 | POA | 417304 | £44.85 | 416304 | POA | 514304 | £82.50 | 518304 | POA |
| 16 | 2P+E | 6h | 220/250 | 411306 | £17.95 | 412306 | POA | 417306 | £45.65 | 416306 | POA | 514306 | POA | 518306 | POA |
| 16 | 3P+E | 6h | 380/415 | | | 411406 | POA | 415406 | £61.10 | 416406 | POA | 514406 | POA | 518406 | POA |
| 16 | 3P+N+E | 6h | 380/415 | | | 411 | POA | 415 | £73.45 | 416 | £124.50 | 514 | POA | 518 | POA |
| 32 | 2P+E | 4h | 110/130 | | | 431304 | POA | 435304 | £89.50 | 436304 | POA | 534304 | POA | 538304 | POA |
| 32 | 2P+E | 6h | 220/250 | | | 431306 | POA | 435306 | £89.50 | 436306 | POA | 534306 | £48.70 | 538306 | £83.35 |
| 32 | 3P+E | 6h | 380/415 | | | 431406 | POA | 435406 | £89.50 | 436406 | POA | 534406 | POA | 538406 | POA |
| 32 | 3P+N+E | 6h | 380/415 | | | 431 | POA | 435 | £97.90 | 436 | POA | 534 | £63.75 | 538 | POA |

APPLIANCE INLETS

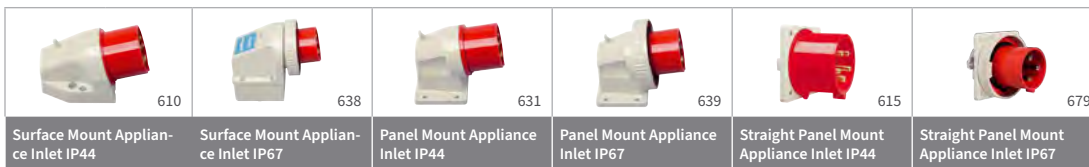

| | | | | Surface Mount Appliance Inlet IP44 | | Surface Mount Appliance Inlet IP67 | | Panel Mount Appliance Inlet IP44 | | Panel Mount Appliance Inlet IP67 | | Straight Panel Mount Appliance Inlet IP44 | | Straight Panel Mount Appliance Inlet IP67 | |
|-----|--------|-----|----------------|------------------------------------|---------|------------------------------------|---------|----------------------------------|---------|----------------------------------|---------|---|--------|---|---------|
| Amp | Pole | ± | Volt | Ref No. | Trade | Ref No. | Trade | Ref No. | Trade | Ref No. | Trade | Ref No. | Trade | Ref No. | Trade |
| 16 | 2P+E | 4h | 110/130 | 610304 | £25.95 | 618304 | £56.95 | 611304 | £46.95 | 619304 | £52.95 | 615304 | £19.35 | 619304ST | POA |
| 16 | 2P+E | 6h | 220/250 | 610306 | £25.95 | 618306 | £56.95 | 611306 | £44.95 | 619306 | £52.95 | 615306 | £16.95 | 619306ST | POA |
| 16 | 2P+E | 9h | 380/415 | 610309 | £50.90 | 618309 | POA | 611309 | £56.85 | 619309 | £54.95 | 615309 | £36.95 | 619309ST | POA |
| 16 | 3P+E | 4h | 110/130 | 610404 | £36.95 | 618404 | POA | 611404 | POA | 619404 | POA | 615404 | £37.95 | 619404ST | POA |
| 16 | 3P+E | 9h | 220/250 | 610409 | £54.85 | 618409 | POA | 611409 | £54.95 | 619409 | £61.50 | 615409 | £39.95 | 619409ST | POA |
| 16 | 3P+E | 6h | 380/415 | 610406 | £32.95 | 618406 | £73.45 | 611406 | £51.25 | 619406 | £58.50 | 615406 | £21.95 | 619406ST | POA |
| 16 | 3P+E | 10h | >50v 100/300hz | 610410 | POA | 618410 | POA | 611410 | POA | 619410 | POA | 615410 | POA | | |
| 16 | 3P+N+E | 4h | 110/130 | 610504 | £55.35 | 618504 | POA | 611504 | £64.95 | 619504 | POA | 615504 | £58.65 | 619504ST | POA |
| 16 | 3P+N+E | 9h | 220/250 | 610509 | £55.35 | 618509 | £82.25 | 611509 | £64.95 | 619509 | POA | 615509 | £58.65 | 619509ST | POA |
| 16 | 3P+N+E | 6h | 380/415 | 610 | £28.60 | 618 | £60.65 | 611 | £51.95 | 619 | £63.95 | 615 | £24.50 | 619ST | POA |
| 16 | 6P+E | 9h | 220/250 | 610709 | £124.95 | | | 611709 | £135.75 | | | 615709 | POA | | |
| 16 | 6P+E | 6h | 380/415 | 610706 | £116.95 | | | 611706 | £106.90 | | | 615706 | POA | | |
| 32 | 2P+E | 4h | 110/130 | 630304 | £38.95 | 638304 | £68.50 | 631304 | £69.95 | 639304 | £95.40 | 635304 | £42.95 | 639304ST | POA |
| 32 | 2P+E | 6h | 220/250 | 630306 | £38.95 | 638306 | £68.50 | 631306 | £44.95 | 639306 | £64.95 | 635306 | £27.65 | 639306ST | POA |
| 32 | 2P+E | 9h | 380/415 | 630309 | £83.40 | 638309 | POA | 631309 | £92.65 | 639309 | £97.50 | 635309 | £70.65 | 639309ST | POA |
| 32 | 3P+E | 4h | 110/130 | 630404 | £74.35 | 638404 | POA | 631404 | £83.95 | 639404 | POA | 635404 | POA | 639404ST | POA |
| 32 | 3P+E | 9h | 220/250 | 630409 | £74.35 | 638409 | POA | 631409 | £83.25 | 639409 | £98.95 | 635409 | £70.30 | 639409ST | POA |
| 32 | 3P+E | 6h | 380/415 | 630406 | £44.95 | 638406 | £71.50 | 631406 | £51.95 | 639406 | £71.60 | 635406 | £28.70 | 639406ST | POA |
| 32 | 3P+E | 10h | >50v 100/300hz | 630410 | POA | 638410 | POA | 631410 | POA | 639410 | POA | 635410 | POA | | |
| 32 | 3P+E | 3h | 440/container | | | | | | | 639403 | £68.20 | | | | |
| 32 | 3P+N+E | 4h | 110/130 | 630504 | £76.95 | 638504 | POA | 631504 | £93.75 | 639504 | POA | 635504 | £71.95 | 639504ST | POA |
| 32 | 3P+N+E | 9h | 220/250 | 630509 | £76.95 | 638509 | POA | 631509 | £93.75 | 639509 | POA | 635509 | £71.95 | 639509ST | POA |
| 32 | 3P+N+E | 6h | 380/415 | 630 | £48.95 | 638 | £77.25 | 631 | £47.80 | 639 | £87.50 | 635 | £33.40 | 639ST | POA |
| 32 | 6P+E | 9h | 220/250 | 630709 | £178.95 | | | 631709 | POA | | | 635709 | POA | | |
| 32 | 6P+E | 6h | 380/415 | 630706 | £163.95 | | | 631706 | £139.95 | | | 635706 | POA | | |
| 63 | 2P+E | 4h | 110/130 | | | 668304 | POA | | | 669304 | £181.80 | 665304 | | 667304ST | POA |
| 63 | 2P+E | 6h | 220/250 | | | 668306 | £172.85 | | | 669306 | £181.80 | 665306 | | 667306ST | POA |
| 63 | 2P+E | 9h | 380/415 | | | 668309 | POA | | | 669309 | POA | 665309 | | 667309ST | POA |
| 63 | 3P+E | 4h | 110/130 | | | 668404 | POA | | | 669404 | POA | 665404 | | 667404ST | POA |
| 63 | 3P+E | 9h | 220/250 | | | 668409 | POA | | | 669409 | £196.95 | 665409 | | 667409ST | POA |
| 63 | 3P+E | 6h | 380/415 | | | 668406 | POA | | | 669406 | £196.95 | 665406 | | 667406ST | POA |
| 63 | 3P+N+E | 4h | 110/130 | | | 668504 | POA | | | 669504 | POA | 665504 | | 667504ST | POA |
| 63 | 3P+N+E | 9h | 220/250 | | | 668509 | POA | | | 669509 | £196.95 | 665509 | | 667509ST | POA |
| 63 | 3P+N+E | 6h | 380/415 | | | 668 | £158.65 | | | 669 | £141.15 | 665 | | 667ST | POA |
| 125 | 2P+E | 4h | 110/130 | | | 678304OK | £524.95 | | | | | | | 679304 | £388.50 |
| 125 | 2P+E | 6h | 220/250 | | | 678306OK | £524.95 | | | | | | | 679306 | £388.50 |
| 125 | 2P+E | 9h | 380/415 | | | 678309OK | POA | | | | | | | 679309 | POA |
| 125 | 3P+E | 4h | 110/130 | | | 678404OK | POA | | | | | | | 679404 | POA |
| 125 | 3P+E | 9h | 220/250 | | | 678409OK | £640.15 | | | | | | | 679409 | £481.60 |
| 125 | 3P+E | 6h | 380/415 | | | 678406OK | £490.20 | | | | | | | 679406 | £468.80 |
| 125 | 3P+N+E | 4h | 110/130 | | | 678504OK | £669.55 | | | | | | | 679504 | POA |
| 125 | 3P+N+E | 9h | 220/250 | | | 678509OK | £669.55 | | | | | | | 679509 | POA |
| 125 | 3P+N+E | 6h | 380/415 | | | 678OK | £573.70 | | | | | | | 679 | £397.95 |

LOCKABLE



| Description | Ref No. | Trade |
|---------------|---------|--------|
| 16a 2p+e 110v | 512304 | £28.75 |
| 16A 2P+E 240V | 512306 | £28.75 |

| Back Boxes 60x60 Centres | |
|--------------------------|--------|
| Ref No. | Trade |
| 10010 | £19.70 |

SPLITTER UNITS









| Description | Ref No. | Trade |
|---------------|---------|-------|
| 16a 2p+e 110v | T362134 | POA |
| 16a 2p+e 240v | T362136 | POA |

| 1 Inlet 3 Outlets IP44 | | |
|------------------------|---------|-------|
| Description | Ref No. | Trade |
| 16a 2p+e 110v | T363134 | POA |
| 16a2p+e 240v | T363136 | POA |







| Description | Ref No. | Trade |
|---------------|---------|-------|
| 16a 3pin | 613300 | POA |
| 16a 4pin | 613400 | POA |
| 16a 5pin | 613500 | POA |
| 32a 3/4pin | 633400 | POA |
| 32a 5 pin | 633500 | POA |
| 63a 3/4/5pin | 663500 | POA |
| 125a 3/4/5pin | 673500 | POA |

SWITCHED INTERLOCKED RCD PROTECTED

| | | | |  | |  | |  | |  | |  | |  | |
|-----|--------|----|---------------|---|---------|---|-----------|---|---------|---|---------|---|---------|---|---------|
| | | | | Switch Interlocked IP44 | | Switch Interlocked IP67 | | Switch Interlocked With RCD Facility IP44 | | Switch Interlocked with RCD Facility IP67 | | Switch Interlocked With RCD Fitted IP44 | | Switch Interlocked with RCD Fitted IP67 | |
| Amp | Pole | ± | Volt | Ref No. | Trade | Ref No. | Trade | Ref No. | Trade | Ref No. | Trade | Ref No. | Trade | Ref No. | Trade |
| 16 | 2P+E | 4h | 110/130 | AT710304 | £167.95 | AT719304 | £194.95 | AU710304TS | £377.95 | AU719304TS | £393.95 | 6302314R | £421.95 | 6303314R | £437.95 |
| 16 | 2P+E | 6h | 220/250 | AT710306 | £163.65 | AT719306 | £211.50 | AU710306TS | £375.75 | AU719306TS | £383.95 | 6302316R | £419.75 | 6303316R | £427.95 |
| 16 | 2P+E | 9h | 380/415 | AT710309 | £240.65 | AT719309 | POA | AU710309TS | POA | AU719309TS | POA | 6302319R | POA | 6303319R | POA |
| 16 | 3P+E | 4h | 110/130 | AT710404 | £301.70 | AT719404 | £243.95 | AU710404TS | POA | AU719404TS | POA | 6302414R | POA | 6303414R | POA |
| 16 | 3P+E | 9h | 220/250 | AT710409 | £301.70 | AT719409 | £254.95 | AU710409TS | POA | AU719409TS | POA | 6302419R | POA | 6303419R | POA |
| 16 | 3P+E | 6h | 380/415 | AT710406 | £183.15 | AT719406 | £205.95 | AU710406TS | £399.60 | AU719406TS | £411.00 | 6302416R | £455.55 | 6303416R | £466.95 |
| 16 | 3P+N+E | 4h | 110/130 | AT710504 | £301.90 | AT719504 | POA | AU710504TS | POA | AU719504TS | POA | 6302514R | POA | 6303514R | POA |
| 16 | 3P+N+E | 9h | 220/250 | AT710509 | £312.55 | AT719509 | POA | AU710509TS | POA | AU719509TS | POA | 6302519R | POA | 6303519R | POA |
| 16 | 3P+N+E | 6h | 380/415 | AT710 | £193.60 | AT719 | £211.60 | AU710TS | £406.00 | AU719TS | £420.00 | 6302516R | £461.95 | 6303516R | £475.95 |
| 32 | 2P+E | 6h | 110/130 | AT730304 | £215.95 | AT739304 | £242.95 | AU730304TS | £405.55 | AU739304TS | £430.95 | 6302334R | £449.55 | 6303334R | £474.95 |
| 32 | 2P+E | 6h | 220/250 | AT730306 | £215.95 | AT739306 | £242.95 | AU730306TS | £400.95 | AU739306TS | £420.95 | 6302336R | £444.95 | 6303336R | £464.95 |
| 32 | 2P+E | 9h | 380/415 | AT730309 | POA | AT739309 | POA | AU730309TS | POA | AU739309TS | POA | 6302339R | POA | 6303339R | POA |
| 32 | 3P+E | 6h | 110/130 | AT730404 | POA | AT739404 | POA | AU730404TS | POA | AU739404TS | POA | 6302434R | POA | 6303434R | POA |
| 32 | 3P+E | 4h | 220/250 | AT730409 | POA | AT739409 | POA | AU730409TS | POA | AU739409TS | POA | 6302439R | POA | 6303439R | POA |
| 32 | 3P+E | 6h | 380/415 | AT730406 | £231.65 | AT739406 | £252.95 | AU730406TS | £434.00 | AU739406TS | £454.15 | 6302436R | £489.95 | 6303436R | £510.10 |
| 32 | 3P+E | 3h | 440/container | | | AT739403 | £285.20 | | | AU739403TS | £503.00 | | | 6303433R | £558.95 |
| 32 | 3P+N+E | 4h | 110/130 | AT730504 | POA | AT739504 | POA | AU730504TS | POA | AU739504TS | POA | 6302534R | POA | 6303534R | POA |
| 32 | 3P+N+E | 9h | 220/250 | AT730509 | POA | AT739509 | POA | AU730509TS | POA | AU739509TS | POA | 6302539R | POA | 6303539R | POA |
| 32 | 3P+N+E | 6h | 380/415 | AT730 | £243.40 | AT739 | £268.95 | AU730TS | £443.00 | AU739TS | £463.00 | 6302536R | £498.95 | 6303536R | £518.95 |
| 63 | 2P+E | 4h | 110/130 | AE760304 | £452.10 | AE769304 | £442.95 | AL760304TS | POA | AL769304TS | POA | 6302364R | POA | 6303364R | POA |
| 63 | 2P+E | 6h | 220/250 | AE760306 | £393.95 | AE769306 | £422.50 | AL760306TS | POA | AL769306TS | £621.85 | 6302366R | POA | 6303366R | £686.95 |
| 63 | 2P+E | 9h | 380/415 | AE760309 | POA | AE769309 | POA | AL760309TS | POA | AL769309TS | POA | 6302369R | POA | 6303369R | POA |
| 63 | 3P+E | 4h | 110/130 | AE760404 | POA | AE769404 | POA | AL760404TS | POA | AL769404TS | POA | 6302464R | POA | 6303464R | POA |
| 63 | 3P+E | 9h | 220/250 | AE760409 | £499.50 | AE769409 | POA | AL760409TS | POA | AL769409TS | POA | 6302469R | POA | 6303469R | POA |
| 63 | 3P+E | 6h | 380/415 | AE760406 | £396.95 | AE769406 | £411.95 | AL760406TS | POA | AL769406TS | £675.70 | 6302466R | POA | 6303466R | £761.95 |
| 63 | 3P+N+E | 4h | 110/130 | AE760504 | POA | AE769504 | POA | AL760504TS | POA | AL769504TS | POA | 6302564R | POA | 6303564R | POA |
| 63 | 3P+N+E | 9h | 220/250 | AE760509 | POA | AE769509 | POA | AL760509TS | POA | AL769509TS | POA | 6302569R | POA | 6303569R | POA |
| 63 | 3P+N+E | 6h | 380/415 | AE760 | £412.10 | AE769 | £440.95 | AL760TS | POA | AL769TS | £692.70 | 6302566R | POA | 6303566R | £778.95 |
| 125 | 2P+E | 6h | 110/130 | | | AO779304 | POA | | | | | | | | |
| 125 | 2P+E | 6h | 220/250 | | | AO779306 | £1,356.95 | | | 6303376 | POA | | | 6303376R | POA |
| 125 | 2P+E | 9h | 380/415 | | | AO779309 | POA | | | | | | | | |
| 125 | 3P+E | 6h | 110/130 | | | AO779404 | POA | | | | | | | | |
| 125 | 3P+E | 4h | 220/250 | | | AO779409 | POA | | | | | | | | |
| 125 | 3P+E | 6h | 380/415 | | | AO779406 | £1,449.95 | | | 6303476 | POA | | | 6303476R | POA |
| 125 | 3P+N+E | 4h | 110/130 | | | AO779504 | POA | | | | | | | | |
| 125 | 3P+N+E | 9h | 220/250 | | | AO779509 | POA | | | | | | | | |
| 125 | 3P+N+E | 6h | 380/415 | | | AO779 | £1,486.70 | | | 6303576 | POA | | | 6303576R | POA |

ALTERNATIVE VARIATIONS

| | | | |  | |  | |  | |  | |  | |
|-----|--------|----|---------|---|---------|---|---------|---|---------|---|---------|---|---------|
| | | | | 2 Gang Portable Outlet Unit | | 2 Gang Outlet 2 metres Cable & Plug IP 44 | | 2 Gang Outlet with 2 metres Cable Plug & RCD Fitted IP 44 | | 3 Gang Portable Outlet Unit | | 3 Gang Outlet 2 metres Cable & Plug IP 44 | |
| Amp | Pole | ± | Volt | Ref No. | Trade | Ref No. | Trade | Ref No. | Trade | Ref No. | Trade | Ref No. | Trade |
| 16 | 2P+E | 4h | 110/130 | 6522314 | £199.95 | 6522314P2 | £220.45 | 6522314P2R | £355.45 | 6532314 | £226.20 | 6532314P2 | £246.70 |
| 16 | 2P+E | 6h | 220/250 | 6522316 | £187.50 | 6522316P2 | £207.95 | 6522316P2R | £342.95 | 6532316 | £213.75 | 6532316P2 | £234.25 |
| 16 | 2P+E | 6h | 380/415 | 6522416 | £230.40 | 6522416P2 | £267.20 | 6522416P2R | £414.15 | 6532416 | £266.35 | 6532416P2 | £303.15 |
| 16 | 3P+N+E | 6h | 380/415 | 6522516 | £236.40 | 6522516P2 | £275.00 | 6522516P2R | £421.95 | 6532516 | £275.35 | 6532516P2 | £313.95 |
| 32 | 2P+E | 4h | 110/130 | 6522334 | £242.50 | 6522334P2 | £283.50 | 6522334P2R | £418.50 | 6532334 | £284.45 | 6532334P2 | £325.50 |
| 32 | 2P+E | 6h | 220/250 | 6522336 | £242.50 | 6522336P2 | £283.50 | 6522336P2R | £418.50 | 6532336 | £284.45 | 6532336P2 | £325.50 |
| 32 | 3P+E | 6h | 380/415 | 6522436 | £252.50 | 6522436P2 | £305.55 | 6522436P2R | £452.50 | 6532436 | £299.45 | 6532436P2 | £352.50 |
| 32 | 3P+N+E | 6h | 380/415 | 6522536 | £260.30 | 6522536P2 | £314.05 | 6522536P2R | £460.95 | 6532536 | £311.15 | 6532536P2 | £364.90 |

SWITCHED WITH RCD SOCKET OUTLETS



| | | | | Socket outlet with RCD Facility IP44 | | Socket outlet with RCD Fitted IP44 | | Socket outlet with RCD Facility IP67 | | Socket outlet with RCD Fitted IP67 | |
|-----|--------|----|---------------|--------------------------------------|---------|------------------------------------|---------|--------------------------------------|---------|------------------------------------|-----------|
| Amp | Pole | ± | Volt | Ref No. | Trade | Ref No. | Trade | Ref No. | Trade | Ref No. | Trade |
| 16 | 2P+E | 4h | 110/130 | 6512314 | £217.95 | 6512314R | £261.95 | 6513314 | £245.95 | 6513314R | £289.95 |
| 16 | 2P+E | 6h | 220/250 | 6512316 | £217.95 | 6512316R | £261.95 | 6513316 | £245.95 | 6513316R | £289.95 |
| 16 | 2P+E | 9h | 380/415 | 6512319 | £273.65 | 6512319R | £317.65 | 6513319 | £279.95 | 6513319R | £325.95 |
| 16 | 3P+E | 4h | 110/130 | 6512414 | £267.00 | 6512414R | £322.95 | 6513414 | £307.85 | 6513414R | £363.80 |
| 16 | 3P+E | 9h | 220/250 | 6512419 | £267.00 | 6512419R | £322.95 | 6513419 | £307.85 | 6513419R | £363.80 |
| 16 | 3P+E | 6h | 380/415 | 6512416 | £266.00 | 6512416R | £321.95 | 6513416 | £294.00 | 6513416R | £349.95 |
| 16 | 3P+N+E | 4h | 110/130 | 6512514 | £269.00 | 6512514R | £324.95 | 6513514 | £314.25 | 6513514R | £370.20 |
| 16 | 3P+N+E | 9h | 220/250 | 6512519 | £269.00 | 6512519R | £324.95 | 6513519 | £314.25 | 6513519R | £370.20 |
| 16 | 3P+N+E | 6h | 380/415 | 6512516 | £268.00 | 6512516R | £323.95 | 6513516 | £295.30 | 6513516R | £351.25 |
| 32 | 2P+E | 6h | 110/130 | 6512334 | £248.95 | 6512334R | £292.95 | 6513334 | £281.95 | 6513334R | £325.95 |
| 32 | 2P+E | 6h | 220/250 | 6512336 | £248.95 | 6512336R | £292.95 | 6513336 | £280.95 | 6513336R | £324.95 |
| 32 | 2P+E | 9h | 380/415 | 6512339 | £281.25 | 6512339R | £325.25 | 6513339 | £312.10 | 6513339R | £356.10 |
| 32 | 3P+E | 6h | 110/130 | 6512434 | £298.80 | 6512434R | £354.75 | 6513434 | £306.00 | 6513434R | £361.95 |
| 32 | 3P+E | 4h | 220/250 | 6512439 | £298.80 | 6512439R | £354.75 | 6513439 | £306.00 | 6513439R | £361.95 |
| 32 | 3P+E | 6h | 380/415 | 6512436 | £276.00 | 6512436R | £331.95 | 6513436 | £304.00 | 6513436R | £359.95 |
| 32 | 3P+E | 3h | 440/container | | | | | 6513433 | £306.00 | 6513433R | £361.95 |
| 32 | 3P+N+E | 4h | 110/130 | 6512534 | £306.40 | 6512534R | £362.35 | 6513534 | £321.00 | 6513534R | £376.95 |
| 32 | 3P+N+E | 9h | 220/250 | 6512539 | £306.40 | 6512539R | £362.35 | 6513539 | £321.00 | 6513539R | £376.95 |
| 32 | 3P+N+E | 6h | 380/415 | 6512536 | £289.00 | 6512536R | £344.95 | 6513536 | £316.55 | 6513536R | £372.50 |
| 63 | 2P+E | 4h | 110/130 | 6212364 | £378.85 | 6212364R | £443.95 | 6213364 | £410.85 | 6213364R | £475.95 |
| 63 | 2P+E | 6h | 220/250 | 6212366 | £378.85 | 6212366R | £443.95 | 6213366 | £418.85 | 6213366R | £473.95 |
| 63 | 2P+E | 9h | 380/415 | 6212369 | £516.35 | 6212369R | £581.45 | 6213369 | £506.35 | 6213369R | £571.45 |
| 63 | 3P+E | 4h | 110/130 | 6212464 | £424.10 | 6212464R | £510.35 | 6213464 | £487.65 | 6213464R | £573.90 |
| 63 | 3P+E | 9h | 220/250 | 6212469 | £424.10 | 6212469R | £510.35 | 6213469 | £487.65 | 6213469R | £573.90 |
| 63 | 3P+E | 6h | 380/415 | 6212466 | £423.15 | 6212466R | £509.40 | 6213466 | £451.35 | 6213466R | £537.60 |
| 63 | 3P+N+E | 4h | 110/130 | 6212564 | £435.45 | 6212564R | £521.70 | 6213564 | £503.85 | 6213564R | £590.10 |
| 63 | 3P+N+E | 9h | 220/250 | 6212569 | £424.10 | 6212569R | £525.70 | 6213569 | £503.85 | 6213569R | £590.10 |
| 63 | 3P+N+E | 6h | 380/415 | 6212566 | £433.70 | 6212566R | £519.95 | 6213566 | £462.25 | 6213566R | £548.50 |
| 125 | 2P+E | 6h | 110/130 | | | | | 6813374 | £813.95 | 6813374R | £1,752.40 |
| 125 | 2P+E | 6h | 220/250 | | | | | 6813376 | £813.95 | 6813376R | £1,631.95 |
| 125 | 2P+E | 9h | 380/415 | | | | | 6813379 | POA | 6813379R | £2,552.15 |
| 125 | 3P+E | 6h | 110/130 | | | | | 6813474 | £976.90 | 6813474R | £1,857.85 |
| 125 | 3P+E | 4h | 220/250 | | | | | 6813479 | £822.45 | 6813479R | £1,879.90 |
| 125 | 3P+E | 6h | 380/415 | | | | | 6813476 | £773.95 | 6813476R | £1,807.95 |
| 125 | 3P+N+E | 4h | 110/130 | | | | | 6813574 | £870.60 | 6813574R | £1,883.30 |
| 125 | 3P+N+E | 9h | 220/250 | | | | | 6813579 | £870.60 | 6813579R | £1,883.30 |
| 125 | 3P+N+E | 6h | 380/415 | | | | | 6813576 | £785.25 | 6813576R | £1,662.85 |

ALTERNATIVE VARIATIONS



| | | | | 2 Gang Outlet With RCD Facility IP44 | | 2 Gang Outlet With RCD Fitted IP 44 | | 2 Gang Outlet With RCD Facility IP67 | | 2 Gang Outlet With RCD Fitted IP 67 | |
|-----|--------|----|---------|--------------------------------------|---------|-------------------------------------|---------|--------------------------------------|---------|-------------------------------------|---------|
| Amp | Pole | ± | Volt | Ref No. | Trade | Ref No. | Trade | Ref No. | Trade | Ref No. | Trade |
| 16 | 2P+E | 4h | 110/130 | 6222314 | £268.50 | 6222314R | £312.50 | 6223314 | £395.95 | 6223314R | £439.95 |
| 16 | 2P+E | 6h | 220/250 | 6222316 | £268.50 | 6222316R | £312.50 | 6223316 | £395.95 | 6223316R | £439.95 |
| 16 | 2P+E | 6h | 380/415 | 6222416 | £342.55 | 6222416R | £398.50 | 6223416 | £299.00 | 6223416R | £354.95 |
| 16 | 3P+N+E | 6h | 380/415 | 6222516 | £350.00 | 6222516R | £405.95 | 6223516 | £393.55 | 6223516R | £449.50 |
| 32 | 2P+E | 4h | 110/130 | 6222334 | £330.95 | 6222334R | £374.95 | 6223334 | £369.95 | 6223334R | £413.95 |
| 32 | 2P+E | 6h | 220/250 | 6222336 | £330.95 | 6222336R | £374.95 | 6223336 | £369.95 | 6223336R | £413.95 |
| 32 | 3P+E | 6h | 380/415 | 6222416 | £342.55 | 6222416R | £398.50 | | | | |
| 32 | 3P+N+E | 6h | 380/415 | 6222536 | £365.55 | 6222536R | £421.50 | | | | |

RCD'S



| Description | Ref No. | Trade |
|---|------------|-------|
| 25a 2pole 30ma | 25A2P30MA | |
| 25a 4pole 30ma | 25A4P30MA | |
| 40a 2pole 30ma | 40A2P30MA | |
| 40a 4pole 30ma | 40A4P30MA | |
| 63a 2pole 30ma | 63A2P30MA | |
| 63a 4pole 30ma | 63A4P30MA | |
| 3 Gang Outlet 2 Meters of Cable & Plug with RCD Fitted IP 44 | | |
| 16a 2p+e 110v | 6532314P2R | |
| 16a 2p+e 240v | 6532316P2R | |

WALL SOCKETS



| | | | | Top Entry Wall Socket IP44 | | Top And Bottom Entry Wall Skt IP44 | | Top And Bottom Entry Wall Skt IP67 | |
|-----|--------|-----|----------------|----------------------------|---------|------------------------------------|---------|------------------------------------|---------|
| Amp | Pole | ± | Volt | Ref No. | Trade | Ref No. | Trade | Ref No. | Trade |
| 16 | 2P+E | 4h | 110/130 | 110304 | £20.95 | 111304 | £36.70 | 119304 | £52.50 |
| 16 | 2P+E | 6h | 220/250 | 110306 | £20.95 | 111306 | £36.25 | 119306 | £47.75 |
| 16 | 2P+E | 9h | 380/415 | 110309 | £31.95 | 111309 | £38.65 | 119309 | £82.45 |
| 16 | 3P+E | 4h | 110/130 | 110404 | £45.00 | 111404 | £45.20 | 119404 | £73.00 |
| 16 | 3P+E | 9h | 220/250 | 110409 | £31.50 | 111409 | £46.15 | 119409 | £76.30 |
| 16 | 3P+E | 6h | 380/415 | 110406 | £24.95 | 111406 | £41.30 | 119406 | £61.60 |
| 16 | 3P+E | 10h | >50v 100/300hz | 110410 | £41.95 | 111410 | POA | 119410 | POA |
| 16 | 3P+N+E | 4h | 110/130 | 110504 | £54.95 | 111504 | £63.65 | 119504 | £127.05 |
| 16 | 3P+N+E | 9h | 220/250 | 110509 | £48.30 | 111509 | £49.40 | 119509 | £91.95 |
| 16 | 3P+N+E | 6h | 380/415 | 110 | £29.40 | 111 | £31.75 | 119 | £62.95 |
| 16 | 6P+E | 9h | 220/250 | 110709 | £125.35 | 111709 | POA | 119709 | POA |
| 16 | 6P+E | 6h | 380/415 | 110706 | £89.95 | 111706 | POA | 119706 | POA |
| 32 | 2P+E | 4h | 110/130 | 130304 | £32.95 | 131304 | £44.55 | 139304 | £90.50 |
| 32 | 2P+E | 6h | 220/250 | 130306 | £31.95 | 131306 | £43.15 | 139306 | £69.40 |
| 32 | 2P+E | 9h | 380/415 | 130309 | £57.75 | 131309 | £68.35 | 139309 | £101.65 |
| 32 | 3P+E | 4h | 110/130 | 130404 | £64.85 | 131404 | £68.35 | 139404 | £104.00 |
| 32 | 3P+E | 9h | 220/250 | 130409 | £54.95 | 131409 | £65.85 | 139409 | £98.35 |
| 32 | 3P+E | 6h | 380/415 | 130406 | £36.15 | 131406 | £47.60 | 139406 | £76.70 |
| 32 | 3P+N+E | 4h | 110/130 | 130504 | £65.95 | 131504 | £82.80 | 139504 | £107.10 |
| 32 | 3P+N+E | 9h | 220/250 | 130509 | £61.60 | 131509 | £82.80 | 139509 | £107.10 |
| 32 | 3P+N+E | 6h | 380/415 | 130 | £41.95 | 131 | £47.50 | 139 | £82.35 |
| 32 | 6P+E | 9h | 220/250 | 130709 | £154.95 | 131709 | POA | 139709 | POA |
| 32 | 6P+E | 6h | 380/415 | 130706 | £142.50 | 131706 | POA | 139706 | POA |
| 63 | 2P+E | 4h | 110/130 | | | 161304 | £128.95 | 169304 | £144.95 |
| 63 | 2P+E | 6h | 220/250 | | | 161306 | £119.95 | 169306 | £138.55 |
| 63 | 2P+E | 9h | 380/415 | | | 161309 | £164.70 | 169309 | £189.95 |
| 63 | 3P+E | 4h | 110/130 | | | 161404 | £175.95 | 169404 | £163.30 |
| 63 | 3P+E | 9h | 220/250 | | | 161409 | £169.30 | 169409 | £188.75 |
| 63 | 3P+E | 6h | 380/415 | | | 161406 | £147.95 | 169406 | £142.75 |
| 63 | 3P+N+E | 4h | 110/130 | | | 161504 | £189.50 | 169504 | £196.95 |
| 63 | 3P+N+E | 9h | 220/250 | | | 161509 | £189.50 | 169509 | £196.95 |
| 63 | 3P+N+E | 6h | 380/415 | | | 161 | £141.75 | 169 | £164.85 |
| 125 | 2P+E | 4h | 110/130 | | | | | 179304OK | £511.20 |
| 125 | 2P+E | 6h | 220/250 | | | | | 179306OK | £511.20 |
| 125 | 2P+E | 9h | 380/415 | | | | | 179309OK | £525.40 |
| 125 | 3P+E | 4h | 110/130 | | | | | 179404OK | £577.50 |
| 125 | 3P+E | 9h | 220/250 | | | | | 179409OK | £548.30 |
| 125 | 3P+E | 6h | 380/415 | | | | | 179406OK | £515.95 |
| 125 | 3P+N+E | 4h | 110/130 | | | | | 179504OK | £555.90 |
| 125 | 3P+N+E | 9h | 220/250 | | | | | 179509OK | £555.90 |
| 125 | 3P+N+E | 6h | 380/415 | | | | | 179OK | £523.50 |

ALTERNATIVE VARIATIONS



| | | | | Mondo Surface Skt IP44 | | Single socket on box IP44 | | Single socket on box IP67 | | Twin Socket on Box IP44 | |
|-----|--------|----|---------|------------------------|--------|---------------------------|--------|---------------------------|---------|-------------------------|---------|
| Amp | Pole | ± | Volt | Ref No. | Trade | Ref No. | Trade | Ref No. | Trade | Ref No. | Trade |
| 16 | 2P+E | 4h | 110/130 | 117304 | £51.90 | 100101134U | £56.95 | 100191134U | £75.20 | 100102134U | £98.95 |
| 16 | 2P+E | 6h | 220/250 | 117306 | £39.95 | 100101136U | £56.95 | 100191136U | £75.20 | 100102136U | £98.95 |
| 16 | 3P+E | 6h | 380/415 | 116406 | £61.10 | 100101146U | £68.95 | 100191146U | £94.95 | 100102146U | £121.95 |
| 16 | 3P+N+E | 6h | 380/415 | 116 | £73.50 | 100101156U | £68.50 | 100191156U | £102.50 | 100102156U | £129.10 |
| 32 | 2P+E | 4h | 110/130 | 136304 | £89.50 | 100101334U | £73.95 | 100191334U | £96.95 | 100102334U | £129.50 |
| 32 | 2P+E | 6h | 220/250 | 136306 | £89.50 | 100101336U | £73.95 | 100191336U | £96.95 | 100102336U | £129.50 |
| 32 | 3P+E | 4h | 380/415 | 136406 | £97.90 | 100101346U | £69.95 | 100191346U | £98.95 | 100102346U | £138.95 |
| 32 | 3P+N+E | 4h | 380/415 | 136 | £92.65 | 100101356U | £85.95 | 100191356U | £104.95 | 100102356U | £148.95 |

| SPALSHPROOF IP44 | | | | | | | | | | WATERTIGHT IP67 | | | | | | | | | |
|--------------------|-----|----------|--------------------|-----|----------|--------------------|-----|----------|--------------------|-----------------|-----------|--------------------|-----|-----------|--------------------|-----|-----------|--|--|
| 16 A 3 P 240 V | 5m | ET213605 | 16A 4P 415V | 5m | ET214605 | 16 A 5 P 415 V | 5m | ET215605 | 16A 3P 240V | 5m | ETW213605 | 16 A 4 P 415 V | 5m | ETW214605 | 16 A 5 P 415 V | 5m | ETW215605 | | |
| | 10m | ET213610 | | 10m | ET214610 | | 10m | ET215610 | | 10m | ETW213610 | | 10m | ETW214610 | | 10m | ETW215610 | | |
| | 15m | ET213615 | | 15m | ET214615 | | 15m | ET215615 | | 15m | ETW213615 | | 15m | ETW214615 | | 15m | ETW215615 | | |
| | 20m | ET213620 | | 20m | ET214620 | | 20m | ET215620 | | 20m | ETW213620 | | 20m | ETW214620 | | 20m | ETW215620 | | |
| | 25m | ET213625 | | 25m | ET214625 | | 25m | ET215625 | | 25m | ETW213625 | | 25m | ETW214625 | | 25m | ETW215625 | | |
| | 30m | ET213630 | | 30m | ET214630 | | 30m | ET215630 | | 30m | ETW213630 | | 30m | ETW214630 | | 30m | ETW215630 | | |
| 32 A 3 P 240 V | 5m | ET233605 | 32A 4P 415V | 5m | ET234605 | 32 A 5 P 415 V | 5m | ET235605 | 32A 3P 240V | 5m | ETW233605 | 32 A 4 P 415 V | 5m | ETW234605 | 32 A 5 P 415 V | 5m | ETW235605 | | |
| | 10m | ET233610 | | 10m | ET234610 | | 10m | ET235610 | | 10m | ETW233610 | | 10m | ETW234610 | | 10m | ETW235610 | | |
| | 15m | ET233615 | | 15m | ET234615 | | 15m | ET235615 | | 15m | ETW233615 | | 15m | ETW234615 | | 15m | ETW235615 | | |
| | 20m | ET233620 | | 20m | ET234620 | | 20m | ET235620 | | 20m | ETW233620 | | 20m | ETW234620 | | 20m | ETW235620 | | |
| | 25m | ET233625 | | 25m | ET234625 | | 25m | ET235625 | | 25m | ETW233625 | | 25m | ETW234625 | | 25m | ETW235625 | | |
| | 30m | ET233630 | | 30m | ET234630 | | 30m | ET235630 | | 30m | ETW233630 | | 30m | ETW234630 | | 30m | ETW235630 | | |
| 63 A 3 P 240 V | 5m | ET263605 | 63A 4P 415V | 5m | ET264605 | 63 A 5P 415 V | 5m | ET265605 | 63 A 3 P 240 V | 5m | ETW263605 | 63 A 4 P 415 V | 5m | ETW264605 | 63 A 5 P 415 V | 5m | ETW265605 | | |
| | 10m | ET263610 | | 10m | ET264610 | | 10m | ET265610 | | 10m | ETW263610 | | 10m | ETW264610 | | 10m | ETW265610 | | |
| | 15m | ET263615 | | 15m | ET264615 | | 15m | ET265615 | | 15m | ETW263615 | | 15m | ETW264615 | | 15m | ETW265615 | | |
| | 20m | ET263620 | | 20m | ET264620 | | 20m | ET265620 | | 20m | ETW263620 | | 20m | ETW264620 | | 20m | ETW265620 | | |
| | 25m | ET263625 | | 25m | ET264625 | | 25m | ET265625 | | 25m | ETW263625 | | 25m | ETW264625 | | 25m | ETW265625 | | |
| | 30m | ET263630 | | 30m | ET264630 | | 30m | ET265630 | | 30m | ETW263630 | | 30m | ETW264630 | | 30m | ETW265630 | | |
| 125 A 3 P 240 V | 5m | ET273605 | 125 A 4 P 415 V | 5m | ET274605 | 125 A 5 P 415 V | 5m | ET275605 | 125 A 3 P 240 V | 5m | ETW273605 | 125 A 4 P 415 V | 5m | ETW274605 | 125 A 5 P 415 V | 5m | ETW275605 | | |
| | 10m | ET273610 | | 10m | ET217610 | | 10m | ET275610 | | 10m | ETW273610 | | 10m | ETW217610 | | 10m | ETW275610 | | |
| | 15m | ET273615 | | 15m | ET217615 | | 15m | ET275615 | | 15m | ETW273615 | | 15m | ETW217615 | | 15m | ETW275615 | | |
| | 20m | ET273620 | | 20m | ET217620 | | 20m | ET275620 | | 20m | ETW273620 | | 20m | ETW217620 | | 20m | ETW275620 | | |
| | 25m | ET273625 | | 25m | ET274625 | | 25m | ET275625 | | 25m | ETW273625 | | 25m | ETW274625 | | 25m | ETW275625 | | |
| | 30m | ET273630 | | 30m | ET274630 | | 30m | ET275630 | - | - | | - | - | | - | - | | | |

| Uni-Box Adabter | | | | | |
|---|------|-----------|---------|------|-----------|
| FROM-TO | PINS | REFERENCE | FROM-TO | PINS | REFERENCE |
| 32A-16A | 5PIN | 356-156M | 32A-16A | 3PIN | 336-136M |
| 63A-32A | 5PIN | 656-356M | 63A-32A | 3PIN | 636-336M |
| 63A-16A | 5PIN | 656-156M | 63A-16A | 3PIN | 636-136M |
| MCB protected adaptor boxes all lengths available | | | | | |



| 1 Metre Cabel | | | |
|---|------|------|-----------|
| Amp | Pole | Volt | Ref No. |
| 16 | 3P | 240 | EBM213601 |
| 16 | 5P | 415 | EBM215601 |
| 16 | 3P | 240 | EBM233601 |
| 16 | 5P | 415 | EBM235601 |
| Mid metered units fitted with cable all lengths available | | | |



Prices shown are recommended Trade Prices and are exclusive of current rate VAT. Discounts may be available through Walther Stockists and Distributors. Delivery is free in mainland UK on all orders over a nett value of £150.00 excluding VAT (except Scottish Highlands & Islands) and all items offered are subject to our Standard Terms and Condition of Sale. (Copies available upon request)

POA: Price on application

Item no. endings (except for Mini combi): CC = Cage tension spring, SK = Screw connection, 01 = Push-in terminal block for loop-through, 03 = Push-In terminal block CC, fused, 04 = Screw connection SK, fused

NEO – MORE THAN A PLUG



THIS PRICE LIST COVERS THE MOST POPULAR PRODUCTS IN OUR RANGE ONLY.



For additional products please see our full
product Catalogues or contact sales on:

Tel: 0161 494 1233

Email: sales@walther.co.uk



walther-electric.co.uk

F. Walther Electrics Ltd
Unit 4 | Cromwell Trading Estate | Bredbury
Stockport | Cheshire