

PRODUCT DATA SHEET

Part number	11113
EAN	4015609005833
Manufacturer	WALTHER-WERKE
WEEE-Reg.-Number:	DE 22131895

Product description

NORVO wall socket for external fixing 32A 2P 2h for low voltage with one top cable entry



Similar image

Detailed product description

WALTHER Wall socket 32A 2P 42V 2h IP44
 low-voltage connector from the NORVO series
 made from PA6 material
 in purple
 with one top cable entry
 for external fixing
 outer dimensions 81x70mm

Ordering Information

Order unit	Piece
Customs number	85366990
Net weight	0,169 kg
Packing quantity (VPE)	10
Length of the packaging	0,31 m
Width of the packaging	0,195 m
Depth of the packaging	0,14 m
Gross weight(VPE)	1,838 kg

Classification system

Classification system	ETIM_6.0
ETIM Class	EC001321

Technical product data

Model	Surface mounted (plaster)
IEC-amperage	32 A
Amperage acc. UL/CSA (for UL-version)	30 A
Number of poles	2
Voltage acc. EN 60309-2	20-25 V / 40-50 V (300 Hz) green
Clock hour position	2 h
Identification colour	Green
RAL-number	6025
Degree of protection (IP)	IP44
Connection system	Screwed terminal
Material	Plastic
Type of fastening	External mounting
Insulated mounting	True

Dimension sheet

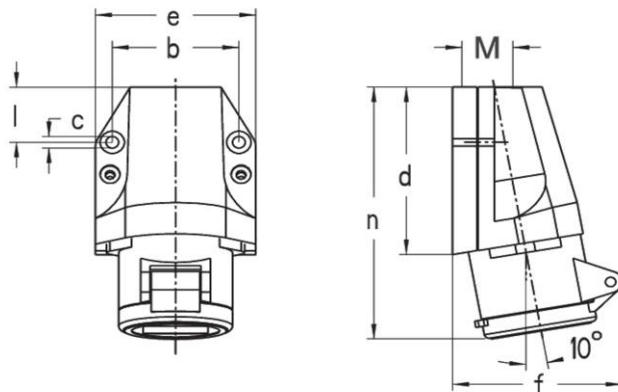

Amp.	16		32	
	2	3	2	3
b	54,5	54,5	54,5	54,5
c	5,2	5,2	5,2	5,2
d	81	81	81	81
e	70	70	70	70
f	72	72	72	72
l	28	28	28	28
n	119	119	119	119
M	25	25	25	25