

PRODUCT DATA SHEET

Part number 11385

EAN 4015609006892

Manufacturer WALTHER-WERKE

WEEE-Reg.-Number: DE 22131895

Product description

NORVO coupler 32A 2P 11h for low voltage with grommet



Similar image

Detailed product description

WALTHER Coupler 32A 2P 42V 11h IP44
 low-voltage connector from the NORVO series
 made from PA6 material
 in purple
 with grommet

Ordering Information

Order unit	Piece
Customs number	85366990
Net weight	0,15 kg
Packing quantity (VPE)	10
Length of the packaging	0,31 m
Width of the packaging	0,195 m
Depth of the packaging	0,14 m
Gross weight(VPE)	1,648 kg

Classification system

Classification system ETIM_6.0

ETIM Class

EC001320

Technical product data

IEC-amperage	32 A
Amperage acc. UL/CSA (for UL-version)	30 A
Number of poles	2
Voltage acc. EN 60309-2	20-25 V / 40-50 V (>400-500 Hz) green
Clock hour position	11 h
Identification colour	Green
RAL-number	6025
Degree of protection (IP)	IP44
Connection system	Screwed terminal
Angle of plug	Straight
Cable entry	Anti-kink sleeve
Material	Plastic

Dimension sheet

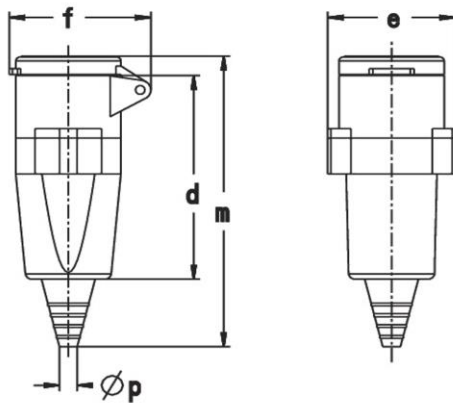

Amp.	16		32	
	2	3	2	3
d	150	150	150	150
e	59	59	59	59
f	67	67	67	67
m	104	104	104	104
Øp	8/21	8/21	8/21	8/21