

PRODUCT DATA SHEET

Part number	11844
EAN	4015609007516
Manufacturer	WALTHER-WERKE
WEEE-Reg.-Number:	DE 22131895

Product description

NORVO appliance inlet for external fixing 32A 3P 3h for low voltage with one top cable entry



Similar image

Detailed product description

WALTHER appliance inlet 32A 3P 42V 3h IP44
 low-voltage connector from the NORVO series
 made from PA6 material
 in purple
 with one top cable entry
 for external fixing
 outer dimensions 81x80mm

Ordering Information

Order unit	Piece
Customs number	85366990
Net weight	0,143 kg
Packing quantity (VPE)	10
Length of the packaging	0,31 m
Width of the packaging	0,195 m
Depth of the packaging	0,14 m
Gross weight(VPE)	1,578 kg

Classification system

Classification system	ETIM_6.0
ETIM Class	EC001319

Technical product data

IEC-amperage	32 A
Amperage acc. UL/CSA (for UL-version)	30 A
Number of poles	3
Voltage acc. EN 60309-2	20-25 V / 40-50 V (400 Hz) green
Clock hour position	3 h
Identification colour	Green
RAL-number	6025
Degree of protection (IP)	IP44
Connection system	Screwed terminal
Connection type	Wall mounted plug
Angle of plug	Angled
Material	Plastic

Dimension sheet

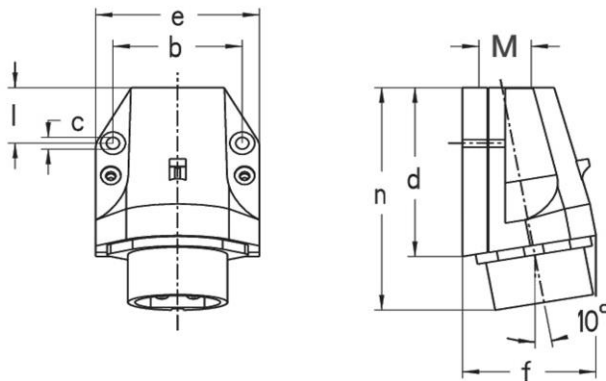

Amp.	16		32	
Pole	2	3	2	3
b	54,5	54,5	54,5	54,5
c	5,2	5,2	5,2	5,2
d	81	81	81	81
e	70	70	70	70
f	68	68	68	68
l	28	28	28	28
n	105	105	105	105
M	25		25	