

PRODUCT DATA SHEET

Part number 139409

EAN 4015609011179

Manufacturer WALTHER-WERKE

WEEE-Reg.-Number: DE 22131895

Product description

Waterproof wall socket for internal fixing 32A 4P 9h with two knock-out cable entries both on top and bottom and knock-out floor entry



Product Image



Detailed product description

WALTHER Wall socket 32A 4P 230V 9h IP67
 made from PA6 material
 with screw terminal
 for internal fixing
 with two knock-out cable entries both top and bottom
 and one knock-out floor entry

Ordering Information

Order unit	Piece
Customs number	85366990
Net weight	0,492 kg
Packing quantity (VPE)	5
Length of the packaging	
Width of the packaging	
Depth of the packaging	
Gross weight(VPE)	2,46 kg

Certificates

VDE certification	123021	
EAC certification	BY112.02.01.020 06089	

Classification system

Classification system	ETIM_6.0
ETIM Class	EC001321

Technical product data

Model	Surface mounted (plaster)
IEC-amperage	32 A
Amperage acc. UL/CSA (for UL-version)	30 A
Number of poles	4
Voltage acc. EN 60309-2	230 V (50+60 Hz) blue
Clock hour position	9 h
Identification colour	Blue
RAL-number	5002
Degree of protection (IP)	IP67
Connection system	Screwed terminal
Material	Plastic
Type of fastening	Inner lying mounting
Insulated mounting	True

Dimension sheet

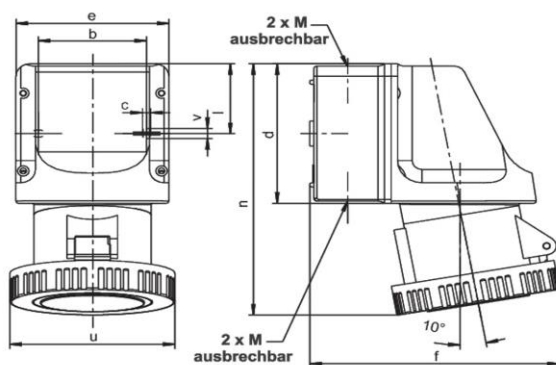

Amp.	16			32		
	3	4	5	3	4	5
b	66,5	66,5	66,5	66,5	66,5	66,5
c	5	5	5	5	5	5
d	96	96	96	96	96	96
e	95	95	95	95	95	95
f	140	144	147	156	156	156
l	47,5	47,5	47,5	47,5	47,5	47,5
n	164	164	164	176	176	176
u	72	81	88	96	96	103
v	7	7	7	7	7	7
M	20/25	20/25	20/25	20/25	20/25	20/25