

PRODUCT DATA SHEET

Part number 212306

EAN 4015609012688

Manufacturer WALTHER-WERKE

WEEE-Reg.-Number: DE 22131895

Product description

Plug 16A 3P 6h with grommet and eye for padlock



Product Image







Detailed product description

WALTHER Plug 16A 3P 230V 6h IP44
 made from PA6 material
 with screw terminal
 with grommet and eye for padlock
 for locking with panel socket 512306/512304/512309
 Increased safety due to injected 2K seal
 and two contact screws.

Ordering Information

Order unit	Piece
Customs number	85366990
Net weight	0,115 kg
Packing quantity (VPE)	10
Length of the packaging	0,31 m
Width of the packaging	0,163 m
Depth of the packaging	0,113 m
Gross weight(VPE)	1,262 kg

Certificates

VDE/ENEC certification	40024787	
UL certification	No. E329476	
UL certification	No. E188992	
CQC certification	2004010203136980	
EAC certification	BY112.02.01.020 06090	
CSA certification	70096522	

Classification system

Classification system	ETIM_6.0
ETIM Class	EC000140

Technical product data

IEC-amperage	16 A
Amperage acc. UL/CSA (for UL-version)	20 A
Number of poles	3
Voltage acc. EN 60309-2	230 V (50+60 Hz) blue
Clock hour position	6 h
Identification colour	Blue
RAL-number	5002
Degree of protection (IP)	IP44
Connection system	Screwed terminal
Cable entry	Anti-kink sleeve
Angle of plug	Straight
Material	Plastic

Dimension sheet

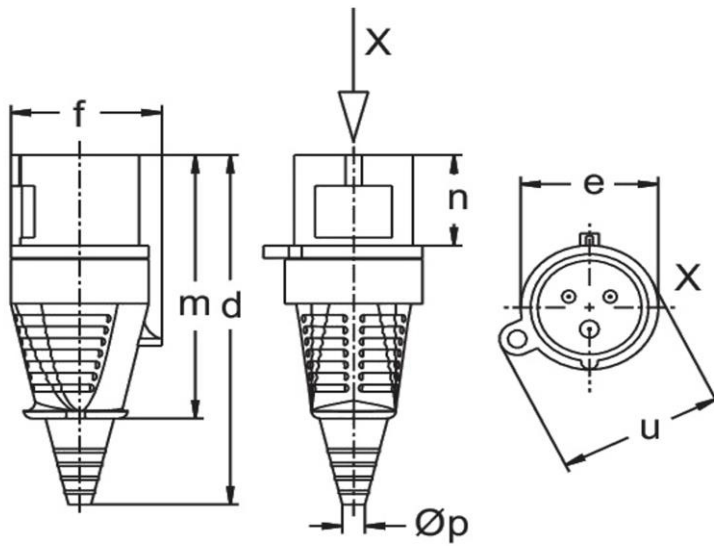

Amp.	16
Pole	3
d	143
e	51
f	60
m	108
n	37
Øp	7/13
u	61