

PRODUCT DATA SHEET

Part number 231SW

EAN 4015609425648

Manufacturer WALTHER-WERKE

WEEE-Reg.-Number: DE 22131895

Product description

Plug 32A 5P 6h with cable gland for lighting and stage technology



Similar image

Detailed product description

WALTHER Plug 32A 5P 400V 6h IP44
 made from PA6 material
 colour: black
 with screw terminal
 and cable gland
 for lighting and stage technology
 Increased safety due to injected 2K seal
 and two contact screws.

Ordering Information

Order unit	Piece
Customs number	85366990
Net weight	0,24 kg
Packing quantity (VPE)	10
Length of the packaging	
Width of the packaging	
Depth of the packaging	
Gross weight(VPE)	2,4 kg

Classification system

Classification system	ETIM_6.0
ETIM Class	EC000140

Technical product data

IEC-amperage	32 A
Amperage acc. UL/CSA (for UL-version)	30 A
Number of poles	5
Voltage acc. EN 60309-2	400 V (50+60 Hz) red
Clock hour position	6 h
Identification colour	Red
Degree of protection (IP)	IP44
Connection system	Screwed terminal
Cable entry	Swivel
Angle of plug	Straight
Material	Plastic

Dimension sheet

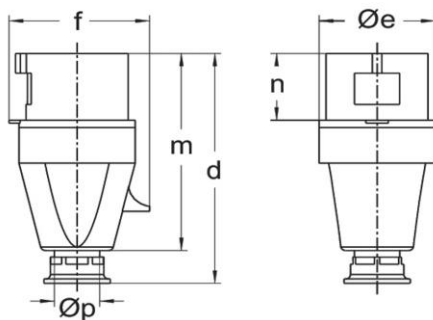

Amp.	16			32			63		
Pole	3	4	5	3	4	5	3	4	5
d	123	131	131	155	155	155	240	240	240
Øe	51	65	65	73	73	73	81	81	81
f	60	68	75	79	79	88	97	97	97
m	118	112	112	133	133	133	192	192	192
n	37	37	37	46	46	46	67	67	67
Øp	7,5-14,5	7,5-14,5	7,5-14,5	10-19,5	10-19,5	10-19,5	18-34,5	18-34,5	18-34,5