

PRODUCT DATA SHEET

Part number 260504

EAN 4015609014682

Manufacturer WALTHER-WERKE

WEEE-Reg.-Nr: DE 22131895

Product description

Plug 63A 5P 4h with grommet



Product Image

Detailed product description

WALTHER Plug 63A 5P 110V 4h IP44
 made from PA6 material
 with screw terminal
 with grommet
 and pilot contact



Ordering information

order unit	Piece
customs number	85366990
net weight	0.575 kg
packing quantity (VPE)	5
length of the packaging	0.31 m
width of the packaging	0.195 m
depth of the packaging	0.14 m
gross weight(VPE)	3.023 kg

Conformities

CE conformity	v
RoHS directive	2011/65/EU
RoHS directive	2015/863/EU
REACH regulation	1907/2006

Certification

VDE certification	40000693	
UL certification	No. E329476	
EAC certification	BY112.02.01.020 06090	

Classification system

classification system	ETIM_7.0
ETIM Class	EC000140

Technical product data

IEC-amperage	63 A
Amperage according to UL/CSA (for UL-version)	60 A
Number of poles	5
Voltage according to EN 60309-2	110 V (50+60 Hz) yellow
Clock hour position	4 h
Identification colour	Yellow
Conductor cross-section	6 - 16 mm ²
Cable diameter	15 - 33 mm
Cable strip length	60 mm +/- 2.5 mm
Cable ferrules length	12 mm +/- 1 mm
Maximum torque terminal screw	2 Nm
Maximum torque back shell	2.5 Nm
Maximum torque cable gland	4 Nm
Maximum torque strain relief	3 Nm
Degree of protection (IP)	IP44
Connection system	Screwed terminal
Contact material	Brass standard
Cable entry	Anti-kink sleeve
Angle of plug	Straight
Material	Plastic
Inflammability class of insulation material according to with UL94	V2

Dimension sheet

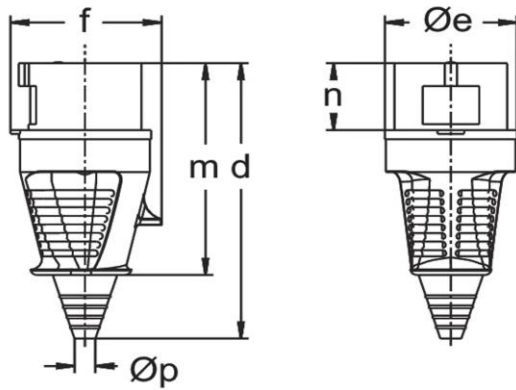

Amp.	16		32	63		
Pole	3	5	5	3	4	5
d	141	153	181	252	252	252
Øe	51	65	72	81	81	81
f	60	75	88	97	97	97
m	108	117	138	192	192	192
n	37	37	46	67	67	67
Øp	7/13	8/21	11/24	15/33	15/33	15/33