

PRODUCT DATA SHEET

Part number 261404

EAN 4015609014811

Manufacturer WALThER-WERKE

WEEE-Reg.-Number: DE 22131895

Product description

Plug 63A 4P 4h with cable gland



Similar image

Detailed product description

WALTHER Plug 63A 4P 110V 4h IP44

made from PA6 material

with screw terminal

and cable gland



Increased safety due to injected 2K seal

and two contact screws.

Ordering Information

Order unit	Piece
Customs number	85366990
Net weight	0,566 kg
Packing quantity (VPE)	5
Length of the packaging	
Width of the packaging	
Depth of the packaging	
Gross weight(VPE)	2,83 kg

Certificates

VDE certification	40000693	
UL certification	No. E329476	
EAC certification	BY112.02.01.020 06090	

Classification system

Classification system	ETIM_6.0
ETIM Class	EC000140

Technical product data

IEC-amperage	63 A
Amperage acc. UL/CSA (for UL-version)	60 A
Number of poles	4
Voltage acc. EN 60309-2	110 V (50+60 Hz) yellow
Clock hour position	4 h
Identification colour	Yellow
RAL-number	1018
Degree of protection (IP)	IP44
Connection system	Screwed terminal
Cable entry	Swivel
Angle of plug	Straight
Material	Plastic

Dimension sheet

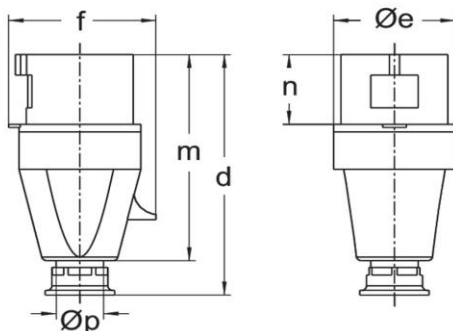

Amp.	16			32			63		
Pole	3	4	5	3	4	5	3	4	5
d	123	131	131	155	155	155	240	240	240
Øe	51	65	65	73	73	73	81	81	81
f	60	68	75	79	79	88	97	97	97
m	118	112	112	133	133	133	192	192	192
n	37	37	37	46	46	46	67	67	67
Øp	7,5-14,5	7,5-14,5	7,5-14,5	10-19,5	10-19,5	10-19,5	18-34,5	18-34,5	18-34,5