

PRODUCT DATA SHEET

Part number 410304

EAN 4015609018369

Manufacturer WALTHER-WERKE

WEEE-Reg.-Number: DE 22131895

Product description

Panel socket straight 16A 3P 4h with flange
62x62mm



Product image





Detailed product description

WALTHER Panel socket 16A 3P 110V 4h IP44
 straight
 made from PA6 material
 finger-safe in accordance with BGV A3
 soft transition
 radius from flange to collar
 flange 62x62
 fixing center 47x47mm

Ordering Information

Order unit	Piece
Customs number	85366990
Net weight	0,1196 kg
Packing quantity (VPE)	10
Length of the packaging	0,31 m
Width of the packaging	0,163 m
Depth of the packaging	0,113 m
Gross weight(VPE)	1,308 kg

Certificates

VDE certification	123017	
UL certification	No. E83342	
CQC certification	2004010203136990	
EAC certification	BY112.02.01.020 06089	

Classification system

Classification system	ETIM_6.0
ETIM Class	EC001317

Technical product data

IEC-amperage	16 A
Amperage acc. UL/CSA (for UL-version)	20 A
Number of poles	3
Voltage acc. EN 60309-2	110 V (50+60 Hz) yellow
Clock hour position	4 h
Identification colour	Yellow
RAL-number	1018
Degree of protection (IP)	IP44
Connection system	Screwed terminal
Angle of plug	Straight
Material	Plastic
Military model	False
Flange size vertical	62 mm
Drill hole distance vertical	47 mm
Flange size horizontal	62 mm
Drill hole distance horizontal	47 mm

Dimension sheet

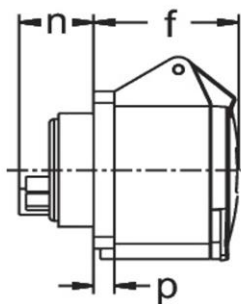
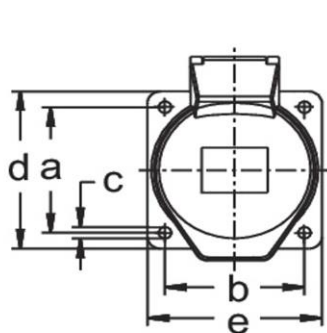

Einbauöffnung

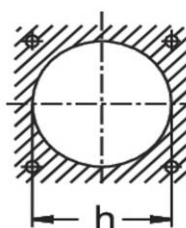

Amp.	16
Pole	3
a	47
b	47
c	5,5
d	62
e	62
f	52
h	46
n	28
p	6