

PRODUCT DATA SHEET

Part number 460404

EAN 4015609020317

Manufacturer WALTHER-WERKE

WEEE-Reg.-Number: DE 22131895

Product description

Panel socket straight 63A 4P 4h with flange
 107x100mm



Product image

Detailed product description

WALTHER Panel socket 63A 4P 110V 4h IP44
 straight
 made from PA6 material
 finger-safe in accordance with BGV A3
 soft transition
 radius from flange to collar
 flange 107x100
 fixing center 85x77

Ordering Information

Order unit	Piece
Customs number	85366990
Net weight	0,645 kg
Packing quantity (VPE)	5
Length of the packaging	0,31 m
Width of the packaging	0,255 m
Depth of the packaging	0,15 m
Gross weight(VPE)	3,421 kg

Certificates

VDE certification	40000707	
UL certification	No. E83342	
EAC certification	BY112.02.01.020 06089	

Classification system

Classification system	ETIM_6.0
ETIM Class	EC001317

Technical product data

IEC-amperage	63 A
Amperage acc. UL/CSA (for UL-version)	60 A
Number of poles	4
Voltage acc. EN 60309-2	110 V (50+60 Hz) yellow
Clock hour position	4 h
Identification colour	Yellow
RAL-number	1018
Degree of protection (IP)	IP44
Connection system	Screwed terminal
Angle of plug	Straight
Material	Plastic
Military model	False
Flange size vertical	107 mm
Drill hole distance vertical	85 mm
Flange size horizontal	100 mm
Drill hole distance horizontal	77 mm

Dimension sheet

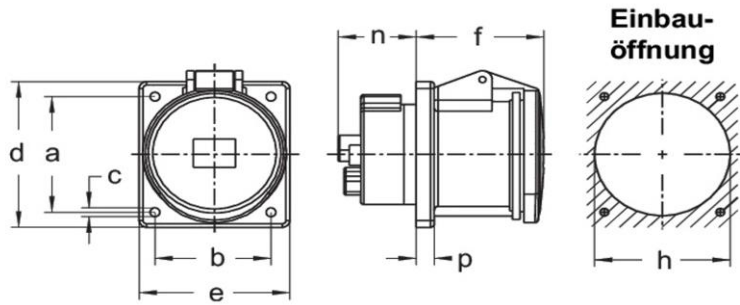

Amp.	63		
Pole	3	4	5
a	85	85	85
b	77	77	77
c	6,5	6,5	6,5
d	107	107	107
e	100	100	100
f	85	85	85
h	90	90	90
n	52	52	52
p	12	12	12